

The Right Source for Electronic Door Controls

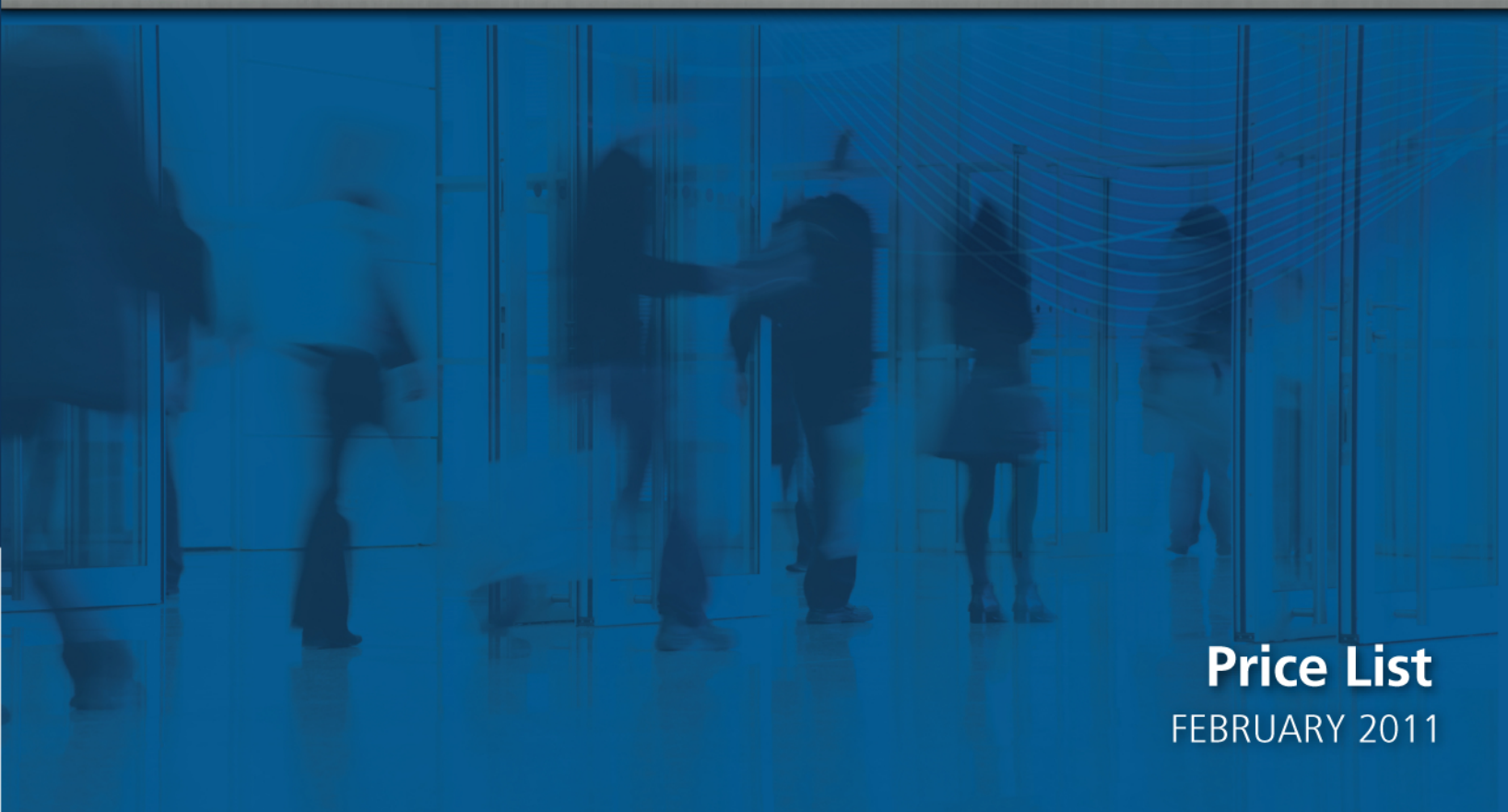

Price List
FEBRUARY 2011

TABLE OF CONTENTS



Electrified Locks, Relays
and Timers



Door Activation Devices



Industrial Door and
Gate Controls



CCTV, Access Control
and Phone Entry



Electric Strikes	3
Electric Cabinet Locks	4
Magnetic Locks	5
Relays and Timers	7
Special Purpose Relays	9
Transformers	10
Power Supplies	10
Illuminated Push Buttons	11
Mushroom Exit Switches	13
Medium Duty Switches	14
Vandal Resistant Switches	15
Economy Push Buttons	17
Parts for Push Buttons	18
Hands-Free Switches	19
Special Purpose Switches	19
All-Active Push Plates	21
Automatic Door Key / Toggle Switches	22
Wireless Door Controls	23
Mounting Posts and Boxes	25
Mounting Options and Compatibility Charts	27
Key Switches and Parts / LED options	29
Power Transfer Cables	32
Keypads	33
Key / Gate Switches	35
Push Button Control Stations	36
Ceiling Pull Switches	36
Telephone Entry Systems	37
Single Door Proximity Card Readers	40
Invision 32 Access Control Systems	41
Exit Watch™ – Covert Cameras	43
Product Index	44
Warranty, Terms and Conditions	45

ELECTRIC STRIKES

Camden strikes are designed for various commercial and industrial applications. They are precision engineered and UL1034 listed. All models are reversible for RH/LH doors and are continuous DC operation. Four stainless steel faceplate options are available. Latch monitoring is optional. Five year warranty.

10/14/18 Series are BHMA Grade 1 heavy duty strikes. Factory tested to 1.5 million cycles; dual voltage and field selectable fail safe/fail secure operation. Deep latch cavity for use with cylindrical lock sets. 14 series models are UL10C and Warnock Hersey fire rated. EZ Fit™ models install in standard ANSI strike plate and are now both horizontally and vertically adjustable. No cutting of frame required.



10 Series
(Shown with optional latch monitoring)

BHMA GRADE 1, 10/14/18 SERIES



Description	STRIKE ONLY NO FACE PLATES		ANSI Square 4 7/8" x 1 1/4"		ANSI Round 4 7/8" x 1 1/4"		Hollow Metal Door 6 7/8" x 1 1/4"		Wood Door 7 15/16" x 1 7/16"		EZ Fit™	
	Model	List Price	Model	List Price	Model	List Price	Model	List Price	Model	List Price	Model	List Price
Fail Safe/Fail Secure 12/24V AC/DC	CX-ED1000	240.00	CX-ED1010	260.00	CX-ED1020	260.00	CX-ED1030	260.00	CX-ED1040	260.00	CX-ED1850A	260.00
As above with latch monitoring	CX-ED1000L	310.00	CX-ED1010L	330.00	CX-ED1020L	330.00	CX-ED1030L	330.00	CX-ED1040L	330.00	CX-ED1850AL	330.00
Fire rated/Fail Secure 12/24V AC/DC	CX-EL1400	420.00	CX-EL1410	440.00	CX-EL1420	440.00	CX-EL1430	440.00	-	-	CX-EL1450A	480.00
As above with latch monitoring	CX-EL1400L	490.00	CX-EL1410L	510.00	CX-EL1420L	510.00	CX-EL1430L	510.00	-	-	CX-EL1450AL	550.00



14 Series
Fire Rated



1850 Series
EZ Fit™

20 Series are BHMA Grade 2, medium duty strikes. Reversible for RH/LH doors, and rated for continuous DC operation.

BHMA GRADE 2, 20 SERIES



Description	STRIKE ONLY NO FACE PLATES		ANSI Square 4 7/8" x 1 1/4"		ANSI Round 4 7/8" x 1 1/4"		Hollow Metal Door 6 7/8" x 1 1/4"		Wood Door 7 15/16" x 1 7/16"	
	Model	List Price	Model	List Price	Model	List Price	Model	List Price	Model	List Price
Fail Safe 12VDC	CX-EU2005	160.00	CX-EU2015	180.00	CX-EU2025	180.00	CX-EU2035	180.00	CX-EU2045	186.00
Fail Safe 24VDC	CX-EU2008	160.00	CX-EU2018	180.00	CX-EU2028	180.00	CX-EU2038	180.00	CX-EU2048	186.00
Fail Secure 8-16V AC/DC	CX-EL2001	140.00	CX-EL2011	160.00	CX-EL2021	160.00	CX-EL2031	160.00	CX-EL2041	166.00
Fail Secure 12VDC	CX-EL2005	140.00	CX-EL2015	160.00	CX-EL2025	160.00	CX-EL2035	160.00	CX-EL2045	166.00
Fail Secure 24VDC	CX-EL2008	140.00	CX-EL2018	160.00	CX-EL2028	160.00	CX-EL2038	160.00	CX-EL2048	166.00



20 Series

22 Series is designed for use with rim or surface mounted exit devices. Suitable for wood or hollow metal doors. Horizontally adjustable for optimal alignment and reversible for RH/LH doors.

BHMA GRADE 2, 22 SERIES - STRIKES COMPLETE WITH FACEPLATES



Description	Model	List Price
Fail Secure, 12VDC	CX-EL2255	316.00
Fail Secure, 24VDC	CX-EL2258	316.00



22 Series

ELECTRIC STRIKES

30/40 Series are BHMA grade 3 strikes. Adjustable keeper allows for easy installation. Reversible for RH/LH doors, and rated for continuous DC operation. EZ Fit™ models require no cutting of door frame for installation, and are horizontally and vertically adjustable for EZ installation.

BHMA GRADE 3, 30 SERIES



NEW FEATURE

STRIKES COMPLETE WITH FACEPLATES

Description	STRIKE ONLY NO FACE PLATES		ANSI Square 4 7/8" x 1 1/4"		ANSI Round 4 7/8" x 1 1/4"		Hollow Metal Door 6 7/8" x 1 1/4"		Wood Door 7 15/16" x 1 7/16"		EZ Fit™	
	Model	List Price	Model	List Price	Model	List Price	Model	List Price	Model	List Price	Model	List Price
Fail secure 8-16V AC/DC	CX-EL3001	124.00	CX-EL3011	144.00	CX-EL3021	144.00	CX-EL3031	144.00	CX-EL3041	150.00	-	-
Fail secure 12V DC	CX-EL3005	124.00	CX-EL3015	144.00	CX-EL3025	144.00	CX-EL3035	144.00	CX-EL3045	150.00	CX-EL3855A	230.00
Fail secure 24V DC	CX-EL3008	124.00	CX-EL3018	144.00	CX-EL3028	144.00	CX-EL3038	144.00	CX-EL3048	150.00	CX-EL3858A	230.00



30 Series

40 SERIES

STRIKES COMPLETE WITH FACEPLATES

Description	STRIKE ONLY NO FACE PLATES		ANSI Square 4 7/8" x 1 1/4"		ANSI Round 4 7/8" x 1 1/4"		Hollow Metal Door 6 7/8" x 1 1/4"		Wood Door 7 15/16" x 1 7/16"	
	Model	List Price	Model	List Price	Model	List Price	Model	List Price	Model	List Price
Fail secure 8-16V AC/DC	CX-EL4001	80.00	CX-EL4011	100.00	CX-EL4021	100.00	CX-EL4031	100.00	CX-EL4041	106.00
Fail secure 12V DC	CX-EL4005	80.00	CX-EL4015	100.00	CX-EL4025	100.00	CX-EL4035	100.00	CX-EL4045	106.00
Fail secure 24V DC	CX-EL4008	80.00	CX-EL4018	100.00	CX-EL4028	100.00	CX-EL4038	100.00	CX-EL4048	106.00



38 Series
EZ Fit™

FACEPLATES - FIT ALL STRIKES EXCEPT 14 & 22 SERIES

Model	Description	List Price
CX-ESP1	ANSI Square, 4 7/8" x 1 1/4" square corners	20.00
CX-ESP2	ANSI Round, 4 7/8" x 1 1/4" rounded corners	20.00
CX-ESP3	Hollow Metal Door, 6 7/8" x 1 1/4" rounded corners	20.00
CX-ESP4	Wood Door, 7 15/16" x 1 7/16" rounded corners	26.00

OPTIONS

Model	Description	List Price
CX-xxxDUR	Duranodic faceplate	N/C

PRODUCT NUMBERING GUIDE

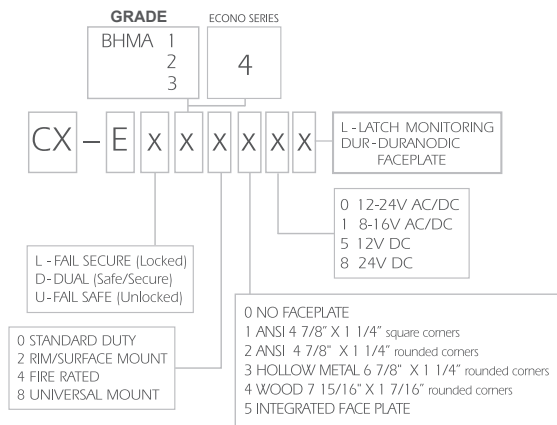

40 Series

CABINET LOCKS

CX-EL8000 and CX-EL8000L Cabinet Locks are ideal for locking drawers, medical storage, lock boxes and display cases. These versatile locks can be installed in either the side or front of drawers and doors. 12/24V, AC/DC operation. Field selectable fail safe/fail secure.

CX-EL8000 SERIES

Model	Description	List Price
CX-EL8000	Electric Cabinet Lock	120.00
CX-EL8000L	Electric Cabinet Lock with latch monitoring contacts	170.00



CX-EL8000 Series

MAGNETIC LOCKS

MAGNETIC LOCKS

- Compatible with all access/egress systems
- Aluminum/stainless steel casings are weather and vandal resistant
- On board MOV's provide protection against voltage spikes and surges
- Assorted mounting brackets and filler plates available

TDS models are supplied with a Lock Sensor (Bond Sensor) to indicate that the door is secure. The built-in timer eliminates the need for add-on exit delay timers. Also included with TDS models: door position switch, relay, and LED.

PRODUCT NUMBERING GUIDE

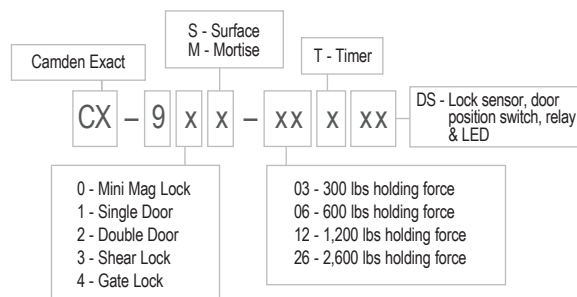

	Model	Description	Current Draw	Dimensions	List Price
1200 lbs Surface Mount Single Door 	CX-91S-12	Basic	500 mA @ 12 V 250 mA @ 24 V	10 1/2" x 2 7/8" x 1 7/8" (267 mm x 73 mm x 48 mm)	280.00
	CX-91S-12TDS	c/w Adjustable Timer, Lock Sensor, Door status Switch, Relay & LED			320.00
1200 lbs Surface Mount Double Doors 	CX-92S-12	Basic	2 x 500 mA @ 12 V 2 x 250 mA @ 24 V	21" x 2 7/8" x 1 7/8" (533 mm x 73 mm x 48 mm)	560.00
	CX-92S-12TDS	c/w Adjustable Timer, Lock Sensor, Door status Switch, Relay & LED			640.00
600 lbs Surface Mount Single Door 	CX-91S-06	Basic	500 mA @ 12 V 250 mA @ 24 V	9 7/8" x 1 7/8" x 1" (251 mm x 48 mm x 25 mm)	220.00
	CX-91S-06TDS	c/w Adjustable Timer, Lock Sensor/Relay & LED			260.00
600 lbs Surface Mount Double Doors 	CX-92S-06	Basic	2 x 500 mA @ 12V 2 x 250 mA @ 24V	19 5/8" x 1 7/8" x 11/16" (498 mm x 48 mm x 17 mm)	440.00
	CX-92S-06TDS	c/w Adjustable Timer, Lock Sensor/Relay & LED			520.00
600 lbs Mortise Mount Single Door 	CX-91M -06	Basic	480 mA @ 12V 240 mA @ 24V	9" x 1 1/2" x 1 1/8" (229 mm x 38 mm x 29 mm)	220.00
	CX-91M -06TLS	c/w Adjustable Timer & Lock Sensor/Relay			260.00
300 lbs Surface Mount Single Door 	CX-90S-03	Basic	360 mA @ 12 V 180 mA @ 24 V	6 1/2" x 1 3/8" x 13/16" (165 mm x 35 mm x 21 mm)	180.00
300 lbs Mortise Mount Single Door 	CX-90M-03	Basic	360 mA @ 12 V 180 mA @ 24 V	8" x 1 3/8" x 13/16" (203 mm x 35 mm x 21 mm)	180.00
1200 lbs Surface Mount Gate Lock 	CX-94S-12LS	c/w Lock Sensor/Relay	500 mA @ 12V 250 mA @ 24V	10 5/8" x 1 3/8" x 1 1/4" (270 mm x 35 mm x 32 mm)	340.00
2600 lbs Shear Lock <ul style="list-style-type: none"> • Ultra low current draw • Compact mortise mount • Self aligning 	CX-93M-26LS	c/w Lock Sensor/Relay	480 mA @ 12 V 240 mA @ 24 V	9 1/16" x 1 1/4" x 1 1/16" (203 mm x 32 mm x 27 mm)	640.00

MAGNETIC LOCKS

MAGNETIC LOCK ACCESSORIES

		Model	Description	Dimensions	List Price
	Armature Housing	CX-0001	For 1200 lbs Magnet	7 15/16" x 3" x 5/8" (202 mm x 76 mm x 16 mm)	38.00
		CX-0011	For 600 lbs Magnet	7 15/16" x 2 3/16" x 5/8" (202 mm x 56 mm x 16 mm)	38.00
	Adjustable L Bracket	CX-1001	For 1200 lbs Magnet	10 1/2" x 3" x 1 1/2" (267 mm x 76 mm x 38 mm)	38.00
		CX-1011	For 600 lbs Magnet	9 13/16" x 1 15/16" x 1 1/8" (250 mm x 49 mm x 29 mm)	30.00
	Set of L & Z Brackets	CX-1002	For 1200 lbs Magnet	10 1/2" x 3" x 1 13/16" (267 mm x 76 mm x 46 mm)	78.00
		CX-1012	For 600 lbs Magnet	6 5/16" x 2 1/2" x 2 1/2" (160 mm x 64 mm x 64 mm) 9 13/16" x 1 13/16" x 1 1/8" (250 mm x 46 mm x 29 mm) 6 3/16" x 2" x 2" (160 mm x 51 mm x 51 mm)	66.00
	Angle Bracket	CX-1003	For 1200 & 600 lbs Mags	10 1/2" x 1 1/2" x 1" (267 mm x 38 mm x 25 mm)	30.00
	Space Bar	CX-1004	For 1200 & 600 lbs Mags	10 1/2" x 11/16" x 5/8" (267 mm x 17 mm x 16 mm)	26.00
	Stainless Steel Surface Mounting Kit	CX-1008	For 2600 lbs shear lock	9 1/4" x 1 5/8" x 1 1/2" (235 mm x 41 mm x 38 mm)	360.00
	Glass Door Mounting Kit	CX-1013	For 1200 and 600 lbs Mags, use on 1/2" or 3/4" thick doors	7 1/4" x 2 7/16" x 1 1/4" (184 mm x 62 mm x 32 mm)	50.00
	Mounting Bracket/Spacer	CX-AL005	For 600 lbs Mags	9 7/8" x 1" x 3/16" (251 mm x 25 mm x 5 mm)	30.00
	Mounting Bracket/Spacer	CX-AL015	For 1200 lbs Mags	10 1/2" x 1 9/16" x 1/4" (267 mm x 40 mm x 32 mm)	30.00

REPLACEMENT PC BOARDS

Model	Description	Dimensions	List Price
CX-91S-06PCB	For 600 lbs. Magnet	2 3/8" x 1 3/4"	60.00
CX-91S-06TLSPCB	For 600 lbs Magnet TLS/TDS	2 3/8" x 1 3/4"	60.00
CX-91S-12PCB	For 1200 lbs Magnet	2 3/8" x 1 3/4"	60.00
CX-91S-12TLSPCB	For 1200 lbs Magnet TLS/TDS	2 3/8" x 1 3/4"	60.00
CX-91S-12PCBV2	For 1200 lbs Magnet	2 3/8" x 1 3/4" (60 mm x 45 mm)	60.00



CX-91S-12PCB



CX-91S-12PCBV2



CX-91S-12TLSPCB

If you are unable to match the photos below with the Mag-lock PC board that you need replaced, contact factory for assistance.

RELAYS AND TIMERS

Exact provides a wide range of practical interface devices for use with mag locks and other electrified door hardware. From basic timers to special purpose relays, we offer solutions for banking, barrier free access, and high-security applications.

ADJUSTABLE TIME DELAYS



MicroMinder	Model	Application	Description	Specs	List Price
	CX-1000/74	Ideal for (de) energizing an electric strike or magnet for an adjustable time, or for use with automatic doors.	<ul style="list-style-type: none"> Ultra compact design Adjustable delay from 1 – 30 seconds Color coded leads & plastic case 	<ul style="list-style-type: none"> 12-24 VAC/DC SPDT contacts rated 3 Amps @ 30 VDC Dimensions: 1 1/4" x 2 1/4" x 3/4" (32 mm x 57 mm x 19 mm) 	56.00
	CX-1000/75	Compact board-only design perfect for integration within boxes or cabinets. Extends time of strikes/electromagnetic locks.	<ul style="list-style-type: none"> Adjustable delay from 1 – 15 seconds Basic easy-to-operate delay-on-release timer 	<ul style="list-style-type: none"> 12-24 VDC operation SPDT contacts rated 2 Amps @ 28 VDC Dimensions: 29/32" x 1 5/8" (23 mm x 41 mm) 	36.00
	CX-1000/77	High precision extended timer uses dipswitches to adjust time delay from 1 second to 4 hours. Sauna/whirlpool/lock control are among its many applications.	<ul style="list-style-type: none"> Adjustable delay from 1 second – 4 hrs. Dipswitch programming for accuracy Normal / fail safe output 	<ul style="list-style-type: none"> 12-24 VDC SPDT contacts rated 5 Amps @ 30 VDC Dimensions: 2" x 3" (51 mm x 76 mm) 	80.00
	CX-1000/78 (Replaces CX-1000/76 and CX-1000/79)	Multi purpose relay can extend time on automatic door operators. Wet input suitable for use with radio controls on apartment entry and fire alarm panels. Delay-on-activate feature is ideal for overhead door or similar applications which require a nuisance delay relay.	<ul style="list-style-type: none"> Adjustable delay from 1 – 30 seconds Adjustable trigger delay of 0 – 10 seconds Latching option Dipswitch programming LCD's for visual relay status 	<ul style="list-style-type: none"> 12-24 VAC/DC SPDT contacts rated 2 Amps @ 28 VDC Dimensions: 2 1/2" x 3 1/2" x 3/4" (64 mm x 89 mm x 19 mm) 	82.00
	CX-247-12 CX-247-24 CX-247H-12 CX-247H-24	With up to 8 flexible daily or weekly (on/off) schedules, the CX-247 can automatically activate/de-activate electric locks and magnets, automatic doors; or control lighting or energy management devices.	<ul style="list-style-type: none"> 8 daily or weekly schedules Internal memory back-up Easy to program / setup Extremely compact size H models feature "First-Man-In" function (holiday/snow day) 	<ul style="list-style-type: none"> 12 VAC/DC or 24 VAC/DC models SPDT contacts rated 16 Amps @ 30 VDC, N/O + N/C Dimensions: 2 3/8" x 2 3/8" x 1 1/4" (60 mm x 60 mm x 32 mm) 	80.00 80.00 120.00 120.00

RELAYS AND TIMERS

ADJUSTABLE TIME DELAYS (CONTINUED)

Pneumatic Time Delays	Model	Application	Description	Specs	List Price
	CX-1085 CX-1085M	Pneumatic time delays require no electricity to operate and work with most Camden key switches (CX-1085) and exit buttons (CX-1085M). The timing range is 1 – 60 seconds, easily adjustable by thumbscrew. Ideal for use where fire/building codes mandate non-electronic means of egress.	<ul style="list-style-type: none"> Pneumatic time delay requires no power to operate Used to de-activate magnetic locks in an emergency Suitable for CM-1200/2200/3200/3500, CM-1000/1100/2000 Key Switches (CX-1085) Suitable for CM-4000-8000 series Exit Switches (CX-1085M) 	<ul style="list-style-type: none"> 1 – 60 second timer DPST form Z contacts, N/O & N/C, rated 5 Amps @ 24V DC Select switch models UL294 / NFPA 101 Compliant 	200.00

DOOR INTERFACE RELAYS

Switching Network	Model	Application	Description	Specs	List Price
	CX-SA-1	A versatile make/break relay, the SA-1 features separate triggers and multiple operating modes, for smoke-evac or uni-directional sequencing applications.	<ul style="list-style-type: none"> Momentary and extended trigger 3 operating modes noise filtering ensures reliability 3 LED's for visual confirmation 	<ul style="list-style-type: none"> 12-24 V AC/DC 2 SPDT contacts rated 2 Amps@30 VDC 3 Timers: 1/4 – 30 seconds Dimensions: 4" x 3 1/2" x 3/4" (104 mm x 88 mm x 19 mm) 	120.00
<p>NEW FEATURE</p> 	CX-12	Make/break relay will (de) energize an electric lock, then after an adjustable delay, activate the operator relay. Bi-Directional Door Sequencer: Sequence two automatic doors in both directions.	<ul style="list-style-type: none"> Bi-Directional Sequencing Mode 3 adjustable delays, up to 30 seconds max. LED's for visual display Accepts wet or dry inputs Maintained output for smoke EVAC 	<ul style="list-style-type: none"> 12/24 V AC/DC operation SPDT contacts rated 3 Amps @ 30V DC Input for connection to telephone entry system One shot design for security Dimensions: 4" x 3 1/2" x 3/4" (104 mm x 83 mm x 19mm) 	126.00

Camden's Lock-Out Relay is used on Automatic Swing Doors to "Lock-out" the safety sensor during the closing cycle of the door. Compatible with most safety sensors and door operators. When used with a guard rail mounted safety beam, the lock-out provides maximum safety on swing doors.

LOCK-OUT RELAY









	Model	Application	Description	Specs	List Price
	CX-PC-6 (Replaces PC-3 and PA-5)	Dual function relay. First, as a basic lock-out-relay (L.O.R.) for header mount sensors on full-speed or low energy doors. Second, as a secondary activation module (SAM) for low-energy doors activated by push button.	<ul style="list-style-type: none"> Suitable for any automatic door operator (even PAC) L.O.R. is timer controlled SAM mode works with any door mount sensor Door position switch is included 	<ul style="list-style-type: none"> Motor/Solenoid Input 6-120 AC/DC 12/24V AC/DC operation Door beam input 2 LED indicators 3 – 30 second timer Dimensions: 2" x 4" x 1" (50 mm x 104 mm x 25 mm) 	110.00



RELAYS AND TIMERS

SPECIAL PURPOSE RELAYS

Dual Function	Model	Application	Description	Specs	List Price
 <p>NOW FOR USE ON BARRIER FREE RESTROOMS</p>	CX-22 (replaces CX-21)	<p>Compact, user-friendly dual-function relay designed to</p> <p>a) sequence two automatic doors in both directions, and</p> <p>b) control restroom doors in shared-use facilities.</p> <p>Applications include barrier-free restrooms in hospitals, nursing homes, hotels; and vestibule sequencing in libraries, shopping malls, banks, restaurants etc.</p>	<ul style="list-style-type: none"> • Micro-processor controlled • Wet/Dry Inputs • Mode Selector switch • Use with: <ul style="list-style-type: none"> - Normally locked or unlocked restroom doors - Fail safe or fail secure locks. • 3 adjustable timers • 2 SPDT outputs • LED's for visual confirmation 	<ul style="list-style-type: none"> • 12 – 24 V AC/DC • 4 inputs – 2 Dry & 2 Wet • 2 SPDT contacts rated 3 Amps @ 30 VDC • 3 Timers: 1 – 30 seconds • Dimensions: 2 1/4" x 3 1/4" x 3/4" (57 mm x 83 mm x 19 mm) 	180.00
	CX-WC	Complete kit includes CX-22 Dual Function Relay, CM-400/8 'Push to Lock' Push Button, and CX-MDC surface mount door contacts			250.00
	CX-WC1	Complete kit includes CX-22 Dual Function Relay, CM-400/8 'Push to Lock' Push Button, CM-30C 'Occupied When Lit' illuminated sign, and CX-MDC surface mount door contacts			290.00
	CX-EMF-2	Camden Door Controls EMF-2 is our second generation Multi-function relay. EMF-2 is designed to easily and quickly handle a variety of specialized door-control tasks	<ul style="list-style-type: none"> • ABM Vestibule Control (Banks) • Single door unsecured restroom in shared-use facility • Single door secured restroom in shared-use facility • Two-door unsecured restroom in shared-use facility • 2/3 door Airlock (with auto-crossing) • 2 – 5 door Airlock • 2 door Mantrap 	<ul style="list-style-type: none"> • Microprocessor control • New Compact design • Accepts up to 8 Inputs • 5 Form C relay outputs • 12-24V AC/DC • Plug-In connectors facilitate wiring • Dimensions: 6 3/4" x 2 15/16" x 1" (172 mm x 75 mm x 25 mm) 	600.00
	CX-EMF-2M	Same as above	<ul style="list-style-type: none"> • Wall mount metal cabinet is lockable and has illuminated ON/Off switch for door status. 	<ul style="list-style-type: none"> • Dimensions: 12" x 7 1/2" x 3 3/4" (304 mm x 190 mm x 95 mm) 	900.00
	CX-EMF-2ABM	Same as above but configured for ABM vestibules	<ul style="list-style-type: none"> • Wall mount metal cabinet is lockable and has two illuminated control switches. 	<ul style="list-style-type: none"> • Dimensions: 12" x 7 1/2" x 3 3/4" (304 mm x 190 mm x 95 mm) 	1000.00

TRANSFORMERS AND POWER SUPPLIES

TRANSFORMERS		Model	Description	List Price
		NIPPLE MOUNT CX-TRN-2024	24 VAC, 20 VA nipple mount transformer	36.00
		STANDARD MOUNT CX-TRX-2012 CX-TRX-4024	12 VAC, 20 VA standard mount transformer 24 VAC, 40 VA standard mount transformer	32.00 38.00
		FUSED, STANDARD MOUNT CX-TRX-2024	24 VAC, 20 VA fused, standard mount transformer	28.00
		PLUG-IN CX-TRP-4012 CX-TRP-4016 CX-TRP-2024	12 VAC, 40 VA plug-in transformer 16 VAC, 40 VA plug-in transformer 24 VAC, 20 VA plug-in transformer	44.00 24.00 40.00
		RECTIFIER CX-5024	Rectifier, (AC-DC Converter) 50 VA	30.00

POWER SUPPLIES		Model	Description	List Price
		CX-PS13 V2	<ul style="list-style-type: none"> • Low cost linear power supply • Compact board-only design • Self-resetting fuse protection • 1 amp. max output • 2-24 VDC • Battery charging • 6 – 26 VAC transformer required (dependent upon output voltage selected) • 2 1/2" x 2 3/8" x 1 1/2" (64 mm x 62 mm x 38 mm) 	38.00
		CX-PS10UL	<ul style="list-style-type: none"> • UL 294, CSA, C22-2 • Latching fire alarm tie-in with reset • 1 amp output • 12 or 24 VDC selectable • AC power and status indicators • Short circuit and terminal protection • Battery charger (400mA) • Enclosure accommodates: one 12V DC/7 AH battery or two 12V DC/4 AH batteries* • 115 VAC power input • Enclosure dimensions: 8 1/2" x 7 1/2" x 3 1/2" (216 mm x 190 mm x 89 mm) 	200.00
		CX-PS30UL	<ul style="list-style-type: none"> • UL 294, UL603, UL14B1, CSFM & MEA • Multi-output power supply • Fire alarm & access control • Trigger connections • 5 individual circuit breakers • Protected outputs • AC fail supervision • DC output and charger supervision • 12/24 VDC output • 2.5 Amp output (CX-PS30UL) • Battery Charger (600mA) • Enclosure accommodates: two 12 V DC/12 AH batteries* • 115 VAC power input • Enclosure dimensions: 15 1/2" x 12" x 4 1/2" (394 mm x 305 mm x 114 mm) 	460.00
		CX-PS60UL	<ul style="list-style-type: none"> • 6 amp output (CX-PS60UL) 	780.00

* Batteries extra

PUSH BUTTONS

ILLUMINATED PUSH BUTTONS

Camden offers the widest selection of illuminated push button switches to support any NFPA compliant access control, ADA compliant automatic door, or industrial control application.

Illuminated Vandal Resistant push buttons are also available on page 15. CM-9600 series buttons are supported with a lifetime warranty and feature piezoelectric sensor button, LED illumination and a 40 second adjustable timer.

Need a custom version of an illuminated push button not shown in this price list? Contact our customer service department today for a quotation.

CM-30 'Universal' 2" Square Illuminated Push Buttons are supplied with a single gang stainless steel faceplate, SPDT momentary switch, wide selection of label inserts, standard and tamperproof mounting screws (with driver). LED bulbs, as well as DPDT switch optional.



CM-30C

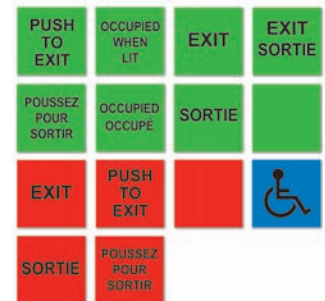

CM-30U



'UNIVERSAL' ILLUMINATED EXIT SWITCHES

NEW



Model	Description	List Price
CM-30U	(12) English and Spanish insert labels, 12V - 28V incandescent	60.00
CM-30U/LED	As above 12V - 24V LED	84.00
CM-30C	(14) English and French insert labels, 12-28V incandescent	60.00
CM-30C/LED	As above 12-24V LED	84.00

The most insert labels offered in the industry

UL294 & UL61058-1 Compliant

Note: For DPDT switch, add 'DP' to product model numbers above: List \$20.00

'ECONOMY' ILLUMINATED EXIT SWITCHES



Model	Description	List Price
CM-30E*	Green switch, 'Push to Exit', 12-28V incandescent	45.00
CM-30 OWL	Green sign, 'Occupied when Lit', 12-28V incandescent	45.00

Save \$ on our most popular models

* **UL294 & UL61058-1 Compliant**

CM-30EE Delayed Egress Switches offer all the features of CM-30 switches with a built-in 30 second electronic timer, and double break circuitry for additional safety. 12/24V operation.

SQUARE ILLUMINATED DELAYED EGRESS

Description	Single Gang Faceplate		Narrow Faceplate	
	Model	List Price	Model	List Price
2" green PUSH TO EXIT button, single gang, deep in-wall mounting box included	CM-30EE*	132.00	-	
Rectangular Green exit button, narrow style	-		CM-310EE	132.00

* **UL294 & UL61058-1 Compliant**

Pneumatic Egress Switches also available! Camden also offers mushroom push button switches with built-in adjustable pneumatic timers to meet the requirements of NFPA 101. CM-4085PTE (1 5/8" button) and CM-5085PTE (2 3/8" button) are ADA, UL294 & UL61058-1 Compliant. See page 13 for details.



CM-30 OWL



CM-30EE



CM-310EE



PUSH BUTTONS

CM-300 Series Rectangular Illuminated Switches are supplied with single gang or narrow stainless steel faceplates. 1/2" x 3/4" illuminated buttons in red or green. Exit logo screened under protective bezel. Momentary operation. Incandescent bulb operates on 12V or 24V DC.

RECTANGULAR ILLUMINATED

Description	Red, Exit		Green, Exit	
	Model	List Price	Model	List Price
Single gang faceplate, SPDT momentary	CM-300R	80.00	CM-300G	80.00
As above 'Push to Exit'	CM-300RPT*	80.00	CM-300GPT*	80.00
Narrow faceplate, SPDT momentary	CM-310R	80.00	CM-310G*	80.00
As above 'Push to Exit'	CM-310RPT*	80.00	CM-310GPT*	80.00

*  **UL294 & UL61058-1 Compliant**

CM-300 LETTERING OPTIONS

Description	
Plain (no wording), delete E suffix	N/C
With SALIDA, add SA suffix	N/C
With Sortie, add S suffix	N/C
With Exit/SALIDA, add ESA suffix	N/C
With Exit/Sortie, add ES suffix	N/C
For other custom lettering, contact factory	



CM-300



CM-310



CM-310PTE

CM-3000 Series Illuminated Mushroom Push Button are supplied with large 1 5/8" red buttons (green optional), incandescent bulb, (12/24V operation), heavy duty cast aluminum faceplate, and contact block.

MUSHROOM ILLUMINATED



Description	Single Gang Faceplate		Narrow Faceplate	
	Model	List Price	Model	List Price
Spring return, N/O, SPST momentary	CM-3000R	126.00	CM-3100R	126.00
Spring return, N/C, SPST momentary	CM-3010R	126.00	CM-3110R	126.00
Spring return, N/O and N/C, DPST momentary	CM-3020R	144.00	CM-3120R	144.00
Push/Pull, N/O SPST maintained	CM-3030R	126.00	CM-3130R	126.00
Push/Pull, N/C SPST maintained	CM-3040R	126.00	CM-3140R	126.00
Push/Pull, N/O and N/C, DPST maintained	CM-3050R	144.00	CM-3150R	144.00

*  **UL61058-1, IEC 61058-2-4 and CAN/CSA-C22.2 Compliant**

CM-3000 COLOR OPTIONS

Description	
Red – standard	N/C
Green – add G suffix, instead of R	N/C



CM-3000



PUSH BUTTONS

Mushroom Exit Switches are available with spring return, push/pull, push/turn to release, or key locking operation. Choice of switch configurations, including adjustable pneumatic time delay. Supplied with a 1 5/8" or 2 3/8" mushroom button (red, blue or green), cast aluminum or 18 gauge stainless steel faceplate, and contact block.

MUSHROOM EXIT SWITCHES – CAST ALUMINUM FACEPLATES

Description	Single Gang 1 5/8" button		Narrow Faceplate 1 5/8" button		Single Gang 2 3/8" button	
	Model	List Price	Model	List Price	Model	List Price
Spring return, N/O, SPST momentary	CM-4000	86.00	CM-4100	86.00	CM-5000	94.00
Spring return, N/C, SPST momentary	CM-4010	86.00	CM-4110	86.00	CM-5010	94.00
Spring return, N/O and N/C, DPST momentary	CM-4020	98.00	CM-4120	98.00	CM-5020	106.00
Push/Pull, N/O, SPST maintained, red only	CM-4030	90.00	CM-4130	90.00	CM-5030	100.00
Push/Pull, N/C, SPST maintained, red only	CM-4040	90.00	CM-4140	90.00	CM-5040	100.00
Push/Pull, N/O and N/C, DPST maintained, red only	CM-4050	102.00	CM-4150	102.00	CM-5050	112.00
Push/Turn to Release, N/O, SPST maintained, red only	–	–	–	–	CM-5060	132.00
Push/Turn to Release, N/C, SPST maintained, red only	–	–	–	–	CM-5070	132.00
Push/Turn to Release, N/O and N/C, DPST maintained, red only	–	–	–	–	CM-5080	146.00
Spring return, DPST 1-60 second pneumatic time delay	CM-4085	300.00	CM-4185	300.00	CM-5085	300.00
Spring return, DPST 1-60 second pneumatic time delay, Push to Exit	CM-4085PTE*	314.00	–	–	CM-5085PTE*	314.00
Push to Lock, key to release, N/O, SPST maintained, red only	–	–	–	–	CM-6030	160.00
Push to Lock, key to release, N/C, SPST maintained, red only	–	–	–	–	CM-6040	160.00
Push to Lock, key to release, N/O and N/C, DPST maintained, red only	–	–	–	–	CM-6050	174.00

COLORS: Add suffix to product number for button color: (R) Red, (B) Blue, (G) Green. If not specified RED will be supplied.

* **UL294 & UL61058-1 Compliant**

ENGRAVING OPTIONS FOR CM-3000/4000/5000/7000/8000

Model	Description	List Price
CM-XXXX-E	Add "E" to product # for EXIT engraved (in white)	14.00
CM-XXXX-ES	Add "ES" to product # for the words EXIT and SORTIE engraved (in white)	20.00
CM-XXXX-ESA	Add "ESA" to product # for the words EXIT and SALIDA engraved (in white)	20.00
CM-XXXX-H	Add "H" to product # for wheelchair symbol engraved (in white)	14.00
CM-XXXX-S	Add "S" to product # for SORTIE engraved (in white)	14.00
CM-XXXX-SA	Add "SA" to product # for SALIDA engraved (in white)	14.00
	For custom engraving or screening, contact factory.	



CM-5085PTE



CM-6000



CM-4100 (Shown with optional logos) CM-4000

PUSH BUTTONS

MUSHROOM EXIT SWITCHES - STAINLESS STEEL FACEPLATES



Description	Single Gang Faceplates						Double Gang Faceplates					
	N/O Contact		N/C		N/O and N/C		N/O Contact		N/C		N/O and N/C	
	Model	List Price	Model	List Price	Model	List Price	Model	List Price	Model	List Price	Model	List Price
Plain faceplate, SPST	CM-400/1	72.00	CM-410/1	72.00	CM-420/1	82.00	CM-500/1	100.00	CM-510/1	100.00	CM-520/1	112.00
With wheelchair logo	CM-400/2	76.00	CM-410/2	76.00	CM-420/2	86.00	CM-500/2	104.00	CM-510/2	104.00	CM-520/2	116.00
With wheelchair, Push to Open and Automatic door loges	CM-400/4	76.00	CM-410/4	76.00	CM-420/4	86.00	CM-500/4	104.00	CM-510/4	104.00	CM-520/4	116.00
With Push to Open	CM-400/6	76.00	CM-410/6	76.00	CM-420/6	86.00	CM-500/6	104.00	CM-510/6	104.00	CM-520/6	116.00
With Push to Exit	CM-400/7	76.00	CM-410/7	76.00	CM-420/7	86.00	–	–	–	–	–	–
With Push to Lock	CM-400/8	76.00	CM-410/8	76.00	CM-420/8	86.00	–	–	–	–	CM-520/8	116.00
Plain faceplate, EXIT engraved on button	–	–	–	–	CM-420E	88.00	–	–	–	–	CM-520E	122.00

COLORS: Add suffix to product number for button color: (R) Red, (B) Blue, (G) Green. If not specified RED will be supplied.
For narrow faceplate add (N) to product # e.g. CM-XXX/XN No Charge.

Ideal for use with CX-22 on barrier free restrooms



CM-400/8



CM-420E



CM-500/2

CM7000/8000 Series provide excellent performance at competitive price points. Solid cast aluminum faceplates with choice of recessed or extended 1" round buttons. CM-7000 series has protective collar around the button. CM-8000 button extends out from the collar for easy access and activation. Pneumatic time delay available with both series.

MEDIUM DUTY SWITCHES



	Recessed Button				Extended Button			
	Single Gang Faceplate		Narrow Faceplates		Single Gang Faceplate		Narrow Faceplates	
	Model	List Price	Model	List Price	Model	List Price	Model	List Price
Spring return, N/O, SPST momentary	CM-7000*	72.00	CM-7100*	72.00	CM-8000*	72.00	CM-8100*	72.00
Spring return, N/C, SPST momentary	CM-7010*	72.00	CM-7110*	72.00	CM-8010*	72.00	CM-8110*	72.00
Spring return, N/O and N/C, DPST momentary	CM-7020*	82.00	CM-7120*	82.00	CM-8020*	82.00	CM-8120*	82.00
Spring return, DPST 1-60 second pneumatic time delay	CM-7085	290.00	CM-7185	290.00	CM-8085	290.00	CM-8185	290.00

COLORS: Add suffix to product number for button color: (R) Red, (G) Green. If not specified RED will be supplied.



CM-8100



CM-7000

* UL61058-1, IEC 61058-2-4 and CAN/CSA-C22.2 Compliant



PUSH BUTTONS

VANDAL RESISTANT SWITCHES

CM-9000 Series Switches are all-steel construction, set in a 1/4" thick aluminum plate. These super tough, low profile switches can withstand attack of all types, even direct hammer blows. Includes faceplate, 7/8" steel button, and security screws.



CM-9080PTE



CM-9180

CM- 9000 SERIES MECHANICAL PUSH BUTTONS

Description	Jamb Width		Single Gang	
	Model	List Price	Model	List Price
DPDT momentary blank	CM-9180	100.00	CM-9080	100.00
DPDT, momentary 'Push to Exit'	CM-9180PTE*	110.00	CM-9080PTE*	110.00
DPDT maintained blank	CM-9190	124.00	CM-9090	124.00

Add E to product #, for EXIT logo silk screened on faceplate (\$10.00 List Price)

Add H to product #, for WHEELCHAIR logo silk screened on faceplate (\$10.00 List Price)



UL294 & UL61058-1 Compliant

LIFETIME WARRANTY

PIEZO Push Switches incorporate a patented non-moving one-piece design, which is virtually impervious to attack or compromise. Tested to 50 million cycles for use under extreme conditions, these sealed aluminum switches carry a LIFETIME WARRANTY.

They are extreme temperature rated -40 C° to +125 C° (-40 F° to +257 F°), with IP68 environmental protection.

Supplied with heavy duty stainless steel or cast aluminum faceplates and security screws.

NO MOVING PARTS

CM-9200/9300 Series are fully sealed piezo push buttons. These "1" round switches are available in red or green, with either a single gang or jamb width stainless steel faceplate.



CM-9280



CM-9380

CM-9200/9300 SERIES PIEZO PUSH BUTTONS

Description	Jamb Width				Single Gang			
	Red		Green		Red		Green	
Model	List Price	Model	List Price	Model	List Price	Model	List Price	
Mom, N/O, 0-24V AC/DC	CM-9380R	104.00	CM-9380G	104.00	CM-9280R	104.00	CM-9280G	104.00

Add E to product #, for EXIT logo silk screened on faceplate (\$10.00 List Price)

Add H to product #, for WHEELCHAIR logo silk screened on faceplate (\$10.00 List Price)

PUSH BUTTONS

CM-9600 Series illuminated piezo switches offer several added features, including an integrated 40 second adjustable timer. Field selectable for fail safe/non fail-safe mode. 12/24 VDC operation with N/O & N/C outputs. May be set for green to red, red to green, or non-illuminated to illuminated operation. Countless applications including REX, automatic doors, building controls, and factory automation. Use optional cable to connect to access control system, to indicate lock status.



CM-9600/7
Red Illumination



CM-9610

CM-9600 SERIES PIEZO PUSH BUTTONS

Description	Single Gang		Narrow Faceplate	
	Model	List Price	Model	List Price
Blank faceplate	CM-9600/1	150.00	CM-9610/1	150.00
Wheelchair logo	CM-9600/2	160.00	CM-9610/2	160.00
Wheelchair/Push to Open	CM-9600/4	160.00	CM-9610/4	160.00
PUSH TO LOCK	CM-9600/5	160.00	CM-9610/5	160.00
PUSH TO OPEN	CM-9600/6	160.00	CM-9610/6	160.00
PUSH TO EXIT	CM-9600/7	160.00	CM-9610/7	160.00
EMPUJE PARA ABRIR	CM-9600/8	160.00	CM-9610/8	160.00
POUSSEZ POUR SORTIR	CM-9600/9	160.00	CM-9610/9	160.00

CM-9600 SERIES PIEZO PUSH BUTTONS OPTIONS

Description	Model	List Price
Cable for remote activation/control of LED	CM-9600/C	10.00



CM-9700 Series piezo switches offer the ultimate in protection against vandalism, inclement weather, and abuse. Solid monoblock aluminum construction. No moving parts to wear out. Solid state output (N/O). No power required to operate. Choice of single gang or jamb widths. Supplied with green PUSH TO EXIT label. French, Spanish, wheelchair labels on request (no charge).



CM-9700

CM-9700 SERIES PIEZO PUSH BUTTONS

Description	Single Gang		Jamb Width (Narrow)	
	Model	List Price	Model	List Price
Green, PUSH TO EXIT	CM-9700	146.00	CM-9710	146.00
Green, EMPUJE PARA ABRIR	CM-9700SP	146.00	CM-9710SP	146.00
Green, POUSSEZ POUR SORTIR	CM-9700F	146.00	CM-9710F	146.00
Blue, WHEELCHAIR LOGO	CM-9700H	146.00	CM-9710H	146.00



CM-9710H

PUSH BUTTONS

Economy Push Buttons feature a 1" red SPDT momentary snap-action button, rated 20 AMPS @30V DC. Choice of stainless steel or plastic faceplates. Various sizes and faceplate logos.

BLUE PLASTIC SURFACE MOUNT ENCLOSURES

Description	Hard Wired		Complete w/RF Transmitter	
	Model	List Price	Model	List Price
Wheelchair logo	CM-150/2	82.00	CM-150/2RC	140.00
Wheelchair /PUSH TO OPEN/Automatic door	CM-150/4	82.00	CM-150/4RC	140.00
PUSH TO OPEN	CM-150/6	82.00	CM-150/6RC	140.00



CM-150/4

UL61058-1, IEC 61058-2-4 and CAN/CSA-C22.2 Compliant

STAINLESS STEEL FACEPLATES

Description	Narrow Jamb		Single Gang	
	Model	List Price	Model	List Price
Plain faceplate	CM-250/1	50.00	CM-280/1	54.00
Wheelchair logo	CM-250/2	54.00	CM-280/2	58.00
Wheelchair/PUSH TO OPEN	CM-250/4	54.00	CM-280/4	58.00
PUSH TO LOCK	CM-250/5	54.00	CM-280/5	58.00
PUSH TO OPEN	CM-250/6	54.00	CM-280/6	58.00
PUSH TO EXIT	CM-250/7	54.00	CM-280/7	58.00
POUSSEZ POUR SORTIR	CM-250/8	54.00	CM-280/8	58.00
Wheelchair/SALIDA	CM-250/9	54.00	CM-280/9	58.00



CM-250/5



CM-280/5

UL61058-1, IEC 61058-2-4 and CAN/CSA-C22.2 Compliant

ALUMINUM FACEPLATES - HORIZONTAL

Description	Narrow Jamb	
	Model	List Price
Horizontal style, Wheelchair logo	CM-200/2H	58.00
Horizontal style, Wheelchair/PUSH TO OPEN	CM-200/4H	58.00
Horizontal style, PUSH TO OPEN	CM-200/6H	58.00



CM-200/6H

PARTS FOR PUSH BUTTONS



CM-45/10



LED'S



CM-3000 Series



CM-7000 Series
(Shown with optional EXIT logo)



CM-8000 Series



CM-3000/40
(Shown with optional LED's)

CONTACT BLOCK/SWITCHES	N/O		N/C		N/O & N/C		DPDT	
	Model	List Price	Model	List Price	Model	List Price	Model	List Price
Description								
For CM-40/41/4 15A @30 V DC	-	-	-	-	CM-45/10	24.00	CM-45/20	34.00
For CM-60 15A @30 V DC	CM-60/10	24.00	CM-60/10	24.00	-	-	-	-
For CM-3000-8000 10A@30V DC	CM-4000/50N	36.00	CM-4000/51N	36.00	CM-4000/54N	46.00	-	-
Additional circuit	CM-4000/60N	24.00	CM-4000/61N	24.00	-	-	-	-

REPLACEMENT BULBS AND LED'S	12V		24V	
	Model	List Price	Model	List Price
Description				
Incandescent Bulb (12/24V) For CM-30 series	CM-30/32	7.00	-	-
Incandescent Bulb (12/24V) For CM-300 series	CM-300/31	7.00	-	-
Red LED (12/24V) For CM-3000 series	CM-3000/37R	20.00	-	-
Green LED (12/24V) For CM-3000 series	CM-3000/37G	20.00	-	-
Red LED	CM-7012	14.00	CM-7024	14.00
Green LED	CM-7112	14.00	CM-7124	14.00
Bi-color LED	CM-7312	16.00	CM-7324	16.00
Amber LED	CM-7412	14.00	CM-7424	14.00

BUTTONS	Red		Blue		Green	
	Model	List Price	Model	List Price	Model	List Price
Description						
Illuminated mushroom (1 5/8")	CM-3000/10N	52.00	-	-	CM-3000/30N	52.00
Illuminated mushroom push/pull	CM-3000/15N	58.00	-	-	CM-3000/34N	58.00
Mushroom (1 5/8") spring return	CM-4000/10N	46.00	CM-4000/20N	46.00	CM-4000/30N	46.00
Mushroom (1 5/8") push/pull	CM-4000/15N	56.00	-	-	-	-
Palm (2 3/8") spring return	CM-5000/10N	56.00	CM-5000/20N	56.00	CM-5000/30N	-
Palm (2 3/8") push/pull	CM-5000/15N	66.00	-	-	-	-
Locking palm (2 3/8") w/keys	CM-6000/10N	110.00	-	-	-	-
Round flush (1")	CM-7000/10N	26.00	-	-	CM-7000/30N	26.00
Round extended (1")	CM-8000/10N	26.00	-	-	CM-8000/30N	26.00
Steel flush (7/8") momentary	CM-9000/10	80.00	-	-	-	-
Steel flush (7/8") maintained	CM-9000/15	90.00	-	-	-	-
Piezo round button (1")	CM-9200/10	88.00	-	-	-	-

FACEPLATES	Jamb Width		Single Gang	
	Model	List Price	Model	List Price
Description				
Brushed aluminum	CM-3000/45	34.00	CM-3000/40	34.00

TAMPERPROOF SCREWS AND BITS	Model	List Price
	Description	
Torx security screws	CM-1000/80	0.60
Torx security screws (box of 100)	CM-1000/81	56.00
Insert bit for Torx security screws	CM-1000/82	8.00
Close-up plug for Piezo Keypads (1)	CM-1000/84	6.00
Security key for CM 100 SS series keypads	CM-1000/88	12.00
Snake eye tamper proof screws (Spanner Head)	CM-1000-90	0.48
Snake eye tamper proof screws (box of 100)	CM-1000/91	40.00
Insert bit for tamper proof screws	CM-1000/92	8.00



SPECIAL PURPOSE SWITCHES

Sure-Wave™ Hands-Free Switches offer the ultimate in performance, public health safety, and convenience.

Sure-Wave™ is recommended for use in barrier-free applications, restrooms, hospitals and clean rooms. Sure-Wave™ is also ideal for commercial and industrial applications where hands-free activation is desired, such as drive-up windows, and kitchen doors in restaurants.

Sure-Wave™ features an operating range of 1-26", adjustable time delay of 1-5 seconds, and provides superior performance in all ambient lighting conditions. Choice of one-piece molded ABS or stainless steel faceplates. May be used in all weather conditions and environments.

Sure-Wave™ operates on 12 – 24 V AC/DC, and has a heavy-duty 5 amp relay, ensuring compatibility with all automatic door operators and electrified locks.



CM-324N

CM-324

CM-324 SURE-WAVE™ ABS FACEPLATES



Description	Jamb Width		Single Gang		Double Gang	
	Model	List Price	Model	List Price	Model	List Price
Plain (blank faceplate)	CM-324/1N	240.00	CM-324/1	240.00	CM-324/1W	240.00
Hand Icon	CM-324/2N	240.00	CM-324/2	240.00	CM-324/2W	240.00
Hand & "Wave to Open"	CM-324/3N	240.00	CM-324/3	240.00	CM-324/3W	240.00



CM-324W

CM-324 SURE-WAVE™ STAINLESS STEEL FACEPLATES



Description	Single Gang		Double Gang	
	Model	List Price	Model	List Price
Plain (blank faceplate)	CM-324/1S	240.00	CM-324/1WS	240.00
Hand Icon	CM-324/2S	240.00	CM-324/2WS	240.00
Hand & "Wave to Open"	CM-324/3S	240.00	CM-324/3WS	240.00



CM-324WS

Remote Door Release Switches may be easily mounted under desks/counters, or on walls. Brushed aluminum NEMA box, or shallow black or beige plastic enclosures. Panel mounted rocker switch – momentary or maintained versions.



ROCKER SWITCHES

Description	SPDT Momentary		SPST Maintained	
	Model	List Price	Model	List Price
NEMA box	CM-810	50.00	CM-820	50.00
Black Plastic	CM-830	36.00	CM-840	36.00
Beige Plastic with Key Symbol	CM-850	50.00	-	-



CM-810/820



CM-830/840



CM-850



SPECIAL PURPOSE SWITCHES

Request-to-Exit Sensor utilizes passive infra-red technology. Dual pyros for increased stability. Ceiling, wall or frame mounted. Adjustable coverage for single and double doors. Adjustable 0.25-60 second timer, 2-24V AC/DC. Two form C relay outputs for activating cameras, remote devices, door shunting or to de-activate mag lock in case of system failure. Fail-safe or fail-secure operation

REQUEST -TO-EXIT SENSOR



White		Silver	
Model	List Price	Model	List Price
CM-419W	150.00	CM-419S	150.00



CM-419W

Pull Stations for emergency release applications in blue and yellow. English, French, and Spanish versions. Clear lift cover and glass-break rods optional.

BLUE PULL STATIONS*

Description	1 x N/C		2 x N/C		1 N/O + 1 N/C	
	Model	List Price	Model	List Price	Model	List Price
Pull for Door Release	CM-701	46.00	CM-702	58.00	CM-703	58.00
Pull in Case of Emergency	CM-701E	46.00	CM-702E	58.00	CM-703E	58.00
As above English/French	CM-701BE	46.00	CM-702BE	58.00	CM-703BE	58.00
As above English/Spanish	CM-701SP	46.00	CM-702SP	58.00	CM-703SP	58.00
Pull for Emergency Assistance	CM-701EA	46.00	CM-702EA	58.00	CM-703EA	58.00
Pull for Emergency Door Release	CM-701EDR	46.00	CM-702EDR	58.00	CM-703EDR	58.00



CM-701

YELLOW PULL STATIONS*

Description	1 x N/C		2 x N/C	
	Model	List Price	Model	List Price
Pull in Case of Emergency	CM-721	54.00	CM-722	66.00



CM-721

(Shown with clear lift cover)

***NOTE:** Switch configurations indicated are when the pull station cover is closed/reset. When pull stations are released, switch contacts will be opposite to those indicated above.

OPTIONS

Description	Model	List Price
For Clear Lift Cover Add	CM-XXXPC	26.00
Plastic Glass-Break Rods (Pack of 10)	CM-700GL	24.00

ALL-ACTIVE PUSH PLATES

All-Active Switches require minimal actuation force, and meet ADA specifications. Constructed from stainless steel or solid brass, with a choice of faceplate designs and finishes. All models feature our exclusive buffed finish, durable 4 stud design, and rubber dampers for smooth and quiet operation.



CM-25

CM-35

CM-2510
(Mortise cylinder sold separately)

CM-2520

JAMB WIDTH, SINGLE GANG AND DOUBLE GANG COMBO



SPST N/O	Jamb Width		Single Gang		Double Gang Combo*		Vestibule Switch	
Description	Model	List Price	Model	List Price	Model	List Price	Model	List Price
No debossing (plain face)	CM-25/1	56.00	CM-35/1	66.00	CM-2510/1	136.00	CM-2520/1	132.00
Wheelchair logo – Blue	CM-25/2	74.00	CM-35/2	80.00	CM-2510/2	150.00	CM-2520/2	168.00
Wheelchair logo arrow left Blue	CM-25/2AL	74.00	-	-	-	-	-	-
Wheelchair logo arrow right Blue	CM-25/2AR	74.00	-	-	-	-	-	-
PUSH TO OPEN – Black	CM-25/3	74.00	CM-35/3	80.00	CM-2510/3	150.00	CM-2520/3	168.00
Wheelchair / PUSH TO OPEN – Blue	CM-25/4	74.00	CM-35/4	80.00	CM-2510/4	150.00	CM-2520/4	168.00
Wheelchair logo PTO arrow left Blue	CM-25/4AL	74.00	-	-	-	-	-	-
Wheelchair logo PTO arrow right Blue	CM-25/4AR	74.00	-	-	-	-	-	-

*Double Gang Combo includes SPST maintained key switch (on/off)

UL61058-1, IEC 61058-2-4 and CAN/CSA-C22.2 Compliant



CM-40



CM-41



CM-45



CM-46



CM-60

PRICE REDUCTION

4 1/2" AND 6" SWITCHES



SPDT	4 1/2" Round		4 1/2" Round w/ Sq. Backplate		4 1/2" Sq. Concealed Mounting Screws		4 1/2" Sq. Exposed Mounting Screws		6" Round	
Description	Model	List Price	Model	List Price	Model	List Price	Model	List Price	Model	List Price
No debossing (plain face)	CM-40/1	90.00	CM-41/1	100.00	CM-45/1	100.00	CM-46/1	100.00	CM-60/1	100.00
Wheelchair logo – Blue	CM-40/2	100.00	CM-41/2	110.00	CM-45/2	110.00	CM-46/2	110.00	CM-60/2	110.00
PUSH TO OPEN – Black	CM-40/3	100.00	CM-41/3	110.00	CM-45/3	110.00	CM-46/3	110.00	CM-60/3	110.00
Wheelchair / PUSH TO OPEN – Blue	CM-40/4	100.00	CM-41/4	110.00	CM-45/4	110.00	CM-46/4	110.00	CM-60/4	110.00
Wheelchair/Poussez Pour Ouvrir – Blue	CM-40/5	130.00	CM-41/5	140.00	CM-45/5	140.00	-	-	CM-60/5	140.00
Poussez Pour Ouvrir – Black	CM-40/6	130.00	CM-41/6	140.00	CM-45/6	140.00	-	-	CM-60/6	140.00
Push to Lock - Black	CM-40/8	130.00	CM-41/8	140.00	CM-45/8	140.00	CM-46/8	140.00	CM-60/8	140.00
Push to Lock Door - Black	CM-40/8D	130.00	CM-41/8D	140.00	CM-45/8D	140.00	CM-46/8D	140.00	CM-60/8D	140.00

UL61058-1, IEC 61058-2-4 and CAN/CSA-C22.2 Compliant



ALL-ACTIVE PUSH PLATES

OPTIONS AND FINISHES

Model	Description	List Price
CM-XXX-DP	Add DP to product # to order DPDT switch instead of SPDT switch	16.00
CM-XXX-WR	Add WR to product # for weather resistant boot	20.00
CM-XXX-WT	Add WT to product # for boot and water tight coating	60.00
CM-XXX-AL	Add AL to product # for arrow left	24.00
CM-XXX-AR	Add AR to product # for arrow right	24.00
CM-XXX-AB	Add AB to product # for antique brass finish (US5 / C5)	120.00
CM-XXX-PB	Add PB to product # for polished brass finish (US3 / C3)	120.00
CM-XXX-SB	ADD SB to product # for satin brass finish (US4 / C4)	120.00
CM-XXX-OB	Add OB to product # for oil rub bronze finish (US10B / C10B)	120.00
CM-XXX-MS	Add MS to product # for mirrored stainless steel finish (US32 / C32)	120.00



CM-XXX-AB



CM-XXX-PB



CM-XXX-SB



CM-XXX-MS



CM-XXX-OB

(Actual product finishes vary from pictures above)

Automatic Door Key Switches, rotary switches, and toggle switches are available with stainless steel or lamacoid faceplates, in 5 different switch configurations, and 11 faceplate formats (English, French, and Spanish). Custom logos and wording available in any language. All key switches are keyed alike. Keys are removable in all positions.

KEY SWITCHES

Description	Lamacoid Faceplate		Narrow Stainless Steel Faceplate		Single Gang Stainless Steel Faceplate	
	Model	List Price	Model	List Price	Model	List Price
Off-Open momentary	CM-160/1	60.00	CM-170/1	64.00	CM-180/1	68.00
Off-Auto maintained	CM-160/2	60.00	CM-170/2	64.00	CM-180/2	68.00
Off-Auto-Hold Open maintained	CM-160/3	64.00	CM-170/3	68.00	CM-180/3	72.00
Off-Auto-Hold Open-Exit maintained	CM-160/4	64.00	CM-170/4	68.00	CM-180/4	72.00
Off-Day-Night maintained	CM-160/6	68.00	CM-170/6	68.00	CM-180/6	72.00



CM-160/6



CM-170/6

 **UL61058-1, IEC 61058-2-4 and CAN/CSA-C22.2 Compliant**

AUTOMATIC DOOR KEY / TOGGLE SWITCHES

Model	Description	List Price
CM-130/4	4 position rotary switch, off/2 way/1 way/hold open	64.00
CM-190/1*	Toggle On/Off, mini aluminum faceplate	32.00
CM-190/2*	Toggle On/Off/Hold Open, mini aluminum faceplate	36.00
CM-190/4*	Toggle On/Off, single gang stainless steel faceplate	36.00
CM-190/5*	Toggle On/Off/Hold Open, single gang stainless steel faceplate	40.00



CM-130/4



CM-190/2

*  **UL61058-1, IEC 61058-2-4 and CAN/CSA-C22.2 Compliant**

Lazerpoint™ RF is a completely new RF solution for automatic door operators and introduces the many advantages of 915MHz. spread spectrum wireless technology. The system encompasses the widest range of transmitters, receivers, activation devices and switch enclosures available today. Lazerpoint RF™ has been designed to provide the very best performance and value in new installations and is 'backwards compatible' for use in retrofit upgrades with 300MHz., 318MHz., 390MHz. and 433MHz. daughterboards.



CM-TX9
Transmitter

NEW

LAZERPOINT RF™ 915MHZ. SPREAD SPECTRUM TRANSMITTERS AND RECEIVERS

Model	Description	List Price
TRANSMITTER		
CM-TX-9	Wall Switch Transmitter, 915MHz.	80.00
RECEIVERS		
CM-RX-91	Basic Single Relay Receiver, 12/24V AC/DC	100.00
CM-RX-92	Full Function Dual Relay Receiver, 12/24V AC/DC	140.00
OPTIONAL PLUG-IN RECEIVERS		
CM-RX-DBB	300MHz. Daughterboard (blue antenna)	60.00
CM-RX-DBO	318MHz. Daughterboard (orange antenna)	60.00
CM-RX-DBR	390MHz. Daughterboard (red antenna)	60.00
CM-RX-DBW	433MHz. Daughterboard (white antenna)	60.00
SERVICE TOOL		
CM-RFCT	Plug-in LED Cable Tool, 33"	60.00



CM-RX92
Receiver

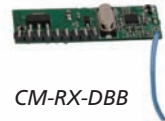

CM-RX-DBB

318MHz. Narrowband Transmitters, Receivers, and Keypads avoid the high cost of running wires to a push switch or key switch. Economical and durable.

318MHZ. TRANSMITTERS, RECEIVERS AND KEYPADS

Model	Description	List Price
CM-TX-7iRM	Wall switch transmitter with instant response module (Pulse Extender)	60.00
CM-TX-8iRM	Micro transmitter for CM-25 series, fits CM-23D jamb box, lithium battery included, with instant response module (Pulse Extender)	70.00
CM-TX-1	One channel, standard size, keychain transmitter	40.00
CM-TX-2	Two channels, standard size, transmitter	50.00
CM-TX-4	Four channels, standard size transmitter	76.00
CM-TX-1M	One channel, keychain transmitter	40.00
CM-TX-2M	Two channels, keychain transmitter	50.00
CM-RX-7	1 channel receiver, 10 code memory, 24 VAC/DC	82.00
CM-TX-480K	Wireless keypad, diecast case, illuminated, unlimited codes	440.00
CM-480C	RF receiver/controller for wireless keypads or transmitters, 12/24 V AC/DC, up to 239 individual codes, or 480 block coded transmitters	200.00



CM-TX-1



CM-TX-2



CM-TX-4



CM-TX-1M



CM-RX-7



CM-480C

Lazerpoint RF™ packages are supplied with 2 TX-9 transmitters, 1 RX-91 receiver, 2 stainless steel all-active switches, and 2 mounting boxes/enclosures. Lazerpoint RF packages are economical to order and are neatly assembled in one box, assuring no missing parts on the jobsite.



RF Package

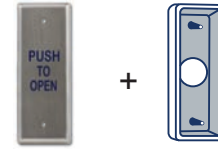

CM-RFL253



CM-RFL403-47

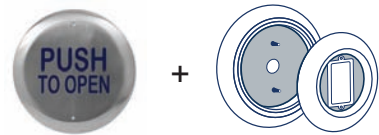

CM-RFL403-49



CM-RFL453



CM-RFL464



CM-RFL603-69

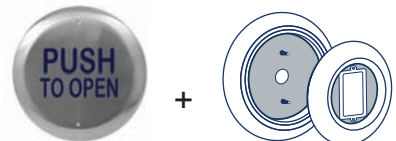

CM-RFL603-79

Jamb Width Switch Packages (CM-25 Series)

Model	Description	List Price
CM-RFL252	Wheelchair Symbol + Surface Box	420.00
CM-RFL253	'Push to Open' + Surface Box	420.00
CM-RFL254	Text and Symbol + Surface Box	420.00

4 1/2" Round Switch Packages (CM-40 Series)

CM-RFL402-47	Wheelchair Symbol + Surface Box	460.00
CM-RFL403-47	'Push to Open' + Surface Box	460.00
CM-RFL404-47	Text and Symbol + Surface Box	460.00
CM-RFL402-49	Wheelchair Symbol + Flush/Surface Kit	460.00
CM-RFL403-49	'Push to Open' + Flush/Surface Kit	460.00
CM-RFL404-49	Text and Symbol + Flush/Surface Kit	460.00

4 1/2" Square Switch Packages (CM-45 Series)

CM-RFL452	Wheelchair Symbol + Surface Box	460.00
CM-RFL453	'Push to Open' + Surface Box	460.00
CM-RFL454	Text and Symbol + Surface Box	460.00

4 1/2" Square Switch Packages (CM-46 Series)

CM-RFL462	Wheelchair Symbol + Surface Box	460.00
CM-RFL463	'Push to Open' + Surface Box	460.00
CM-RFL464	Text and Symbol + Surface Box	460.00

6" Round Switch Packages (CM-60 Series)

CM-RFL602-69	Wheelchair Symbol + Surface Box	460.00
CM-RFL603-69	'Push to Open' + Surface Box	460.00
CM-RFL604-69	Text and Symbol + Surface Box	460.00
CM-RFL602-79	Wheelchair Symbol + Flush/Surface Kit	460.00
CM-RFL603-79	'Push to Open' + Flush/Surface Kit	460.00
CM-RFL604-79	Text and Symbol + Flush/Surface Kit	460.00

NOTE: RECEIVER OPTION: Add 'D' to Switch Package # for CM-RX-92 Dual Relay Receiver in place of CM-RX-91. List Price \$40.00.



MOUNTING OPTIONS FOR ALL-ACTIVE SWITCHES



Mounting Enclosures Camden offers an extensive range of ABS plastic and metal boxes, enclosures and trim rings for flush or surface mounting. ABS plastic models are flame and vandal resistant suitable for use with radio controls. Chart below shows the most popular configurations. See our switch compatibility chart on pages 27 and 28 for a complete listing of mounting options and dimensions.

MOUNTING ENCLOSURES

(To Fit) Switch	ABS Surface Mount		S/S Surface Mount		S/S Flush Mount		Shallow Surface Kit		Offset Jamb		S/S Dress Plate	
	Model	List Price	Model	List Price	Model	List Price	Model	List Price	Model	List Price	Model	List Price
CM-25	CM-23	24.00	—	—	—	—	—	—	—	—	—	—
CM-25 (RF)	CM-23D	30.00	—	—	—	—	—	—	—	—	—	—
CM-2510/2520	CM-53	44.00	—	—	—	—	—	—	—	—	—	—
CM-35	CM-34BL	30.00	CM-31	32.00	CM-66	80.00	—	—	—	—	—	—
CM-40	CM-49	54.00	—	—	CM-66	80.00	—	—	—	—	CM-440	36.00
CM-40	CM-47S	48.00	CM-59S	120.00	—	—	—	—	—	—	—	—
CM-41	CM-43CBL*	30.00	—	—	CM-66	80.00	CM-48AL	40.00	CM-44	70.00	—	—
CM-45/CM-46	CM-43CBL*	30.00	—	—	CM-66	80.00	CM-48AL	40.00	CM-44	70.00	—	—
CM-60	CM-63CBL*	38.00	CM-67	40.00	CM-66	80.00	CM-68AL	40.00	CM-64	70.00	CM-660	36.00
CM-60	CM-69S	48.00	CM-89S	120.00	—	—	—	—	—	—	—	—
CM-60	CM-79	54.00	—	—	—	—	—	—	—	—	—	—

* Weather resistant gasket available for outdoor use, CM-43G List Price 8.00



CM-31



CM-44



CM-440



CM-66



CM-67



CM-68AL

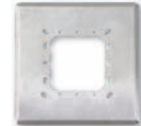

CM-660



CM-23



CM-23D



CM-34BL



CM-43CBL



CM-47S



CM-69S



CM-63CBL

Stainless Steel Escutcheons. For mounting 4 1/2" round (CM-40 series) and 6" round switches (CM-60 series). Solid one-piece construction protects switch from vandalism and abuse.

STAINLESS STEEL ESCUTCHEONS

Model	Description	List Price
CM-59S	For 4 1/2" round switches (CM-40 series)	120.00
CM-89S	For 6" round switches (CM-60 series)	120.00



CM-89S



MOUNTING OPTIONS FOR ALL-ACTIVE SWITCHES

Mounting Posts are available in 42" (38" switch height) and 48" (44" switch height) models, constructed from 1/8" extruded aluminum. They are available in clear aluminum, dark bronze anodized, and mill finishes (suitable for painting). Posts are supplied with a flame and impact resistant ABS post cap, steel mounting base, and stainless steel mounting hardware. The rounded post cap is designed for safety and easy installation of Lazerpoint RF™ 915Mhz. wireless transmitter and battery pack. An optional in-ground mounting base has re-bar welded to the base and is supplied instead of the standard mounting base.



CM-42IG
(Optional)
In-ground
mounting
base

CM-42 BSU-BRZ
(CM-60/2 6" Push Plate
shown, sold separately)

MOUNTING POSTS						
Aluminum Finish			Dark Bronze Finish		Mill Finish	
Description	Model	List Price	Model	List Price	Model	List Price
42" Single gang switch prep	CM-42-BSU-CLR	380.00	CM-42-BSU-BRZ	400.00	CM-42-BSU-MIL	380.00
48" Single gang switch prep (Fits CM-35/40/41/45/46/60 series)	CM-48-BSU-CLR	420.00	CM-48-BSU-BRZ	440.00	CM-48-BSU-MIL	420.00
42" No switch prep (no cut-out)	CM-42-CSU-CLR	360.00	CM-42-CSU-BRZ	380.00	CM-42-CSU-MIL	360.00
In-ground mounting option	All Models				CM-42-IG	26.00

ABS Plastic Escutcheons. Vandal and weather resistant low profile escutcheons for mounting 4 1/2" round switches (CM-40 series) and 6" round switches (CM-60 series). Constructed of high impact, flame proof ABS. Patented 2-piece design and ideal for use with Lazerpoint RF™ wireless transmitters. Front section (CM-49A / 79A) attaches to in-wall one gang, two gang, or 4 x 4 boxes. Use CM-49B / 79B for surface mounting.

"SPACESHIP" ENCLOSURES		
Model	Description	List Price
FOR 4 1/2" ROUND SWITCHES		
CM-49	Complete kit includes CM-49A, CM-49B, CM-49C adapter plate, and CM-49G gasket	54.00
CM-49A	Flush enclosure only (fits single gang box)	26.00
CM-49AK	Flush enclosure, adapter plate, gasket (fits single, double and 4x4 boxes)	34.00
CM-49B	Surface mount enclosure only (must be used with CM-49A)	20.00
CM-49C	Adapter plate. For mounting CM-49A or CM-79A on double gang or 4 x 4 boxes	8.00
CM-49G	Gasket for CM-49A or CM-49B	6.00
FOR 6" ROUND SWITCHES		
CM-79	Complete kit includes CM-79A, CM-79B, CM-49C adapter plate, and CM-79G gasket	54.00
CM-79A	Flush enclosure only (fits single gang box)	26.00
CM-79AK	Flush enclosure, adapter plate, gasket (fits single, double and 4x4 boxes)	34.00
CM-79B	Surface mount enclosure only (must be used with CM-79A)	20.00
CM-79G	Gasket for CM-79A or CM-79B	6.00



CM-49A **CM-49B**
(Shown with optional
TX-9 Transmitter)



CM-79A **CM-79B**
(Shown with optional
TX-9 Transmitter)



CAMDEN SWITCH & ENCLOSURE COMPATIBILITY CHART

Style	Enclosure / Post	Dimensions L x W x D (in)	Surface(S) or Flush(F) Enclosure Material ³	CM-25	CM-30	CM-30EE	CM-35	CM-40	CM-41 ²	CM-45/46 ²	CM-60	CM-130	CM-150	CM-160	CM-170	CM-180	CM-190/1 or 190/2
Jamb Box	CM-23	4 1/2 x 1 3/4 x 1 1/4	P S	✓													
	CM-23D (suitable for RF)	4 1/2 x 1 3/4 x 1 1/2	P S	✓												✓	
Single Gang Enclosure	CM-34AL	4 3/8 x 2 5/8 x 2	A S				✓										✓
	CM-34BL	4 1/2 x 2 3/4 x 1 3/4	P S				✓										✓
	CM-34D	3 x 2 1/4 x 3 1/2	P F		✓	✓	✓	✓	✓	✓	✓	✓					✓
Double Gang Enclosure	CM-43CBL	5 x 5 x 2	P S						✓	✓							
	CM-44	4 1/2 x 4 1/2 x 3/4	S S						✓	✓							
	CM-48AL	4 1/2 x 4 1/2 x 3/4	A S						✓	✓							
	CM-53	5 x 5 x 2	P S							✓							
	CM-63CBL	5 x 5 x 2	P S						✓		✓						
	CM-64	4 x 4 x 13/16	S S								✓	✓					
	CM-66	7 x 7 x 2	S F		✓	✓	✓	✓	✓	✓	✓	✓					✓
	CM-68AL / BZ	4 x 4 x 3/4	A S									✓					
Round	CM-47S	5 diameter	P S					✓									
	CM-49	8 3/4 (S) / 7 (F) dia.	P S/F					✓									
	CM-59S	7 diameter	P S					✓									
	CM-69S	6 1/2 diameter	P S									✓					
	CM-79	9 5/8 (S) / 8 (F) dia.	P S/F									✓	✓				
	CM-89	9 diameter	S S									✓	✓				
Post	CM-42BSU / CM-48BSU *1	6 x 6 x 42/48	A		✓	✓	✓	✓	✓	✓	✓						✓
	CM-42CSU / CM-48CSU *1	6 x 6 x 42/48	A	✓													
Also fits...	Jamb mount (1 3/4" framing)			✓								✓		✓	✓		✓
	Single gang electrical box (Use CM-31 stainless steel sleeve on surface mount 1 gang boxes)						✓	✓	✓	✓	✓						✓
	Double gang electrical box 4 x 4 electrical box (use CM-67 stainless steel sleeve on surface mount 4 x 4 boxes)									✓	✓	✓					
Notes	Box included w/switch																✓
	Extra deep box required				✓	✓											
Enclosure Photographs: (not to scale)																	
	CM-23	CM-23D	CM-31	CM-34AL	CM-34BL	CM-34D	CM-43CBL	CM-44	CM-48AL	CM-47S	CM-49						
List Price	24.00	30.00	32.00	30.00	30.00	30.00	30.00	70.00	40.00	44.00	44.00	44.00	44.00	44.00	44.00	44.00	54.00

*1 CM-42BSU has a single-gang cutout. CM-42CSU has no cutout, and is suitable for mounting key switches, keypads, etc.
 *2 The CM-49C Adapter plate allows single-gang mount switches (ie: CM-41/45/46) to mount to double-gang or 4 x 4 boxes. Adapter plate included with CM-60.
 *3 Enclosure material Code: P = Flame retardant polymer, A = aluminum, S = stainless steel

CM-190/3 or 190/4	CM-250	CM-280	CM-300	CM-310	CM-310EE	CM-324/N/W	CM-400/400D	CM-500	CM-700	CM-1000	CM-1100/1200	CM-2000/2200	CM-2510/2520	CM-3000	CM-3100	CM-4085 to 8085	CM-5000	Enclosure / Post		
	✓			✓		✓ _N												CM-23	Jamb Box	
	✓			✓		✓ _N							✓					CM-23D	Jamb Box	
	✓		✓	✓		✓	✓		✓		✓						✓	CM-34AL	Single Gang Enclosure	
	✓		✓	✓		✓	✓		✓		✓						✓	CM-34BL	Single Gang Enclosure	
	✓		✓	✓		✓ _W	✓		✓		✓				✓		✓	CM-34D	Single Gang Enclosure	
						✓ _W												CM-43CBL	Double Gang Enclosure	
						✓ _W												CM-44		
								✓					✓					CM-48AL		
																	✓	CM-53		
																		✓		CM-63CBL
																		✓		CM-64
	✓		✓	✓		✓	✓		✓		✓						✓	CM-66	Double Gang Enclosure	
																		CM-68AL / BZ		
																		CM-47S	Round	
																		CM-49		
																		CM-59S		
																		CM-69S		
																		CM-79		
																		CM-89	Round	
	✓		✓	✓		✓	✓		✓		✓			✓	✓	✓	✓	CM-42BSU / CM-48BSU *1	Post	
						✓ _N									✓	✓		CM-42CSU / CM-48CSU *1	Post	
	✓			✓	✓	✓ _N					✓			✓				Jamb mount (1 3/4" frame)	Also fits...	
			✓	✓		✓	✓		✓		✓			✓				Single gang electrical box (Use CM-31 s/s sleeve)		
						✓ _W			✓		✓		✓	✓				Double gang electrical box 4 x 4 electrical box (Use CM-67 s/s sleeve)		
							✓ _W												Double gang electrical box 4 x 4 electrical box (Use CM-67 s/s sleeve)	Also fits...

																		Box included w/switch	Notes
																		Extra deep box required	



CM-53

44.00



CM-63CBL

38.00



CM-64

70.00



CM-66

80.00



CM-67

40.00



CM-68AL

40.00



CM-69S

44.00



CM-89S

120.00



CM-42/48

Enclosure Photographs:
(not to scale)

List Price

KEY SWITCHES

Heavy Duty Key Switches are available in surface or flush mount versions. Choice of cast aluminum or industrial grade stainless steel faceplates. May be used with virtually all mortise cylinders and cams. Quick and easy to install, Camden key switches are fast becoming the industry standard. Complete units include faceplate, choice of switch, cylinder lock ring, 2 socket/slotted screws, and 2 tamperproof screws. LED's optional. **Mortise cylinders, keyed alike (KA) or keyed different (KD) sold separately.** See P. 31 for LED and cylinder options.



CM-2000
(Shown with optional LED's. Mortise cylinder sold separately)



CM-1100
(Shown with optional LED's. Mortise cylinder sold separately)



CM-1000
(Mortise cylinder sold separately)

CAST ALUMINUM KEY SWITCHES

Description	Narrow		Single Gang (flush)		Single Gang w/Surface Mount Box	
	Model	List Price	Model	List Price	Model	List Price
SPST momentary, N/O	CM-2000	86.00	CM-1100	86.00	CM-1000	106.00
SPST momentary, N/C	CM-2005	86.00	CM-1105	86.00	CM-1005	106.00
SPST maintained	CM-2010	86.00	CM-1110	86.00	CM-1010	106.00
SPDT momentary	CM-2020	94.00	CM-1120	94.00	CM-1020	114.00
SPDT maintained	CM-2030	94.00	CM-1130	94.00	CM-1030	114.00
(2) SPDT momentary	CM-2050	134.00	CM-1150	134.00	CM-1050	154.00
(2) SPDT maintained	CM-2060	134.00	CM-1160	134.00	CM-1060	154.00
SPDT momentary and SPDT maintained	CM-2070	134.00	CM-1170	134.00	CM-1070	154.00
DPDT momentary	CM-2080	112.00	CM-1180	112.00	CM-1080	132.00
DPST 1-60 second pneumatic time delay	CM-2085	280.00	CM-1185	280.00	-	-
DPDT maintained	CM-2090	112.00	CM-1190	112.00	CM-1090	132.00

UL61058-1, IEC 61058-2-4 and CAN/CSA-C22.2 Compliant

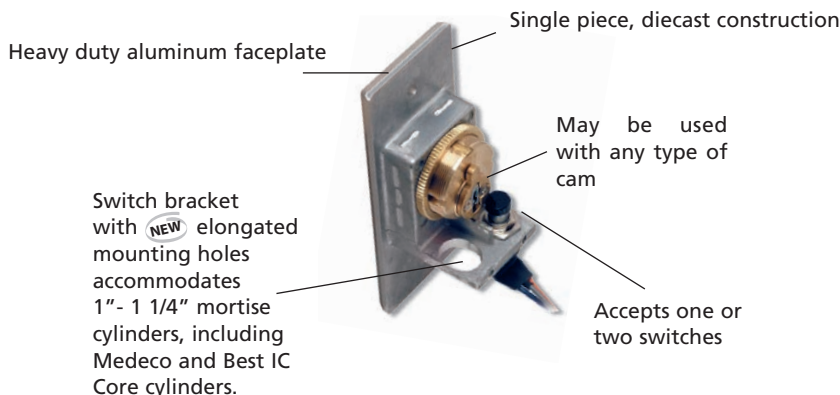

KEY SWITCHES

STAINLESS STEEL KEY SWITCHES

Description	Narrow		Single Gang		Double Gang		Double Gang Dual Cylinder*	
	Model	List Price	Model	List Price	Model	List Price	Model	List Price
SPST momentary, N/O	CM-2200	92.00	CM-1200	92.00	CM-3200	120.00	CM-3500	170.00
SPST momentary, N/C	CM-2205	92.00	CM-1205	92.00	CM-3205	120.00	CM-3505	170.00
SPST maintained	CM-2210	92.00	CM-1210	92.00	CM-3210	120.00	CM-3510	170.00
SPDT momentary	CM-2220	110.00	CM-1220	110.00	CM-3220	134.00	CM-3520	190.00
SPDT maintained	CM-2230	110.00	CM-1230	110.00	CM-3230	134.00	CM-3530	190.00
(2) SPDT momentary	CM-2250	148.00	CM-1250	148.00	CM-3250	172.00	CM-3550	290.00
(2) SPDT maintained	CM-2260	148.00	CM-1260	148.00	CM-3260	172.00	CM-3560	290.00
SPDT momentary and SPDT maintained	CM-2270	148.00	CM-1270	148.00	CM-3270	172.00	CM-3570	290.00
DPDT momentary	CM-2280	122.00	CM-1280	122.00	CM-3280	148.00	CM-3580	236.00
DPST 1-60 second pneumatic time delay	CM-2285	290.00	CM-1285	290.00	CM-3285	346.00	CM-3585	680.00
DPDT maintained	CM-2290	122.00	CM-1290	122.00	CM-3290	148.00	CM-3590	236.00



CM-2200



CM-1200

*Dual cylinder models are supplied with twice the number of switches, lock nuts, and mounting hardware than a single cylinder model.



UL61058-1, IEC 61058-2-4 and CAN/CSA-C22.2 Compliant

NOTE:

1. SPST— Single Pole, Single Throw Switch may be ordered with normally open (N/O) or normally closed (N/C) contacts.
2. SPDT – Single Pole, Double Throw Switch may be wired normally open (N/O) or normally closed (N/C).
3. DPDT – Double Pole, Double Throw Switch may be wired normally open (N/O) or normally closed (N/C).

See page 31 for special finishes and led options



CM-3200



CM-3500

(Shown with mortise cylinders, sold separately)

KEY SWITCHES

PARTS FOR CAMDEN KEY SWITCHES

Model	Description	List Price
CM-34AL	Surface mount box for CM-1000 (previously CM-1000/05)	30.00
CM-1000/10	Aluminum faceplate for CM-1000	58.00
CM-1100/10	Aluminum faceplate for CM-1100	58.00
CM-2000/10	Aluminum faceplate for CM-2000	58.00
CM-1000/21	Neoprene gasket for CM-1000, 1100, 1200	5.00
CM-2000/21	Neoprene gasket for CM-2000, 2200	5.00
CM-1200/10	Stainless Steel Faceplate for CM-1200	72.00
CM-2200/10	Stainless Steel Faceplate for CM-2200	72.00
CM-3200/10	Stainless Steel Faceplate for CM-3200	92.00
CM-3500/10	Stainless Steel Faceplate for CM-3500	120.00
CM-1000/30	SPST momentary contact switch, N/O, 6A @ 30V DC	22.00
CM-1000/31	SPST momentary contact switch, N/O, Heavy Duty, 15 A @ 30V DC	28.00
CM-1000/32	SPST momentary contact switch, N/C, 6A @ 30V DC	22.00
CM-1000/35	SPST maintained contact (on/off) switch, 6A @ 30V DC	22.00
CM-1000/37	SPST maintained contact switch, heavy duty, 15 A @ 30V DC	30.00
CM-1000/40	SPDT momentary contact switch, 6A @ 30V DC	34.00
CM-1000/42	DPDT momentary contact switch, 6A @ 30V DC	44.00
CM-1000/45	SPDT maintained contact switch, 6A @ 30V DC	34.00
CM-1000/47	DPDT maintained contact switch, 6A @ 30V DC	44.00
CM-1000/50	Cylinder lock ring	4.00
CM-1000/60KD	Mortise cylinder, 1 1/8", solid brass, Schlage keyway, aluminum finish, keyed different	20.00
CM-1000/60KA	Mortise cylinder as above, keyed alike, 10 pcs or less	20.00
CM-1000/80KA	Mortise cylinder, keyed alike, 11 pcs or more	34.00
CX-1085	1-60 second pneumatic time delay, DPST	200.00
CM-307	Mortise cylinder housing for Best style IC core (special order)	40.00
CM-308	Best style IC core, keyed different (special order)	46.00



LED OPTIONS/FINISHES

Model	Description	List Price
CM-XXXX-7012	Red 12V LED (add suffix 7012 to desired model number)	16.00
CM-XXXX-7112	Green 12V LED (add suffix 7112 to desired model number)	16.00
CM-XXXX-7212	Red and Green 12V LEDs (add suffix 7212 to desired model number)	32.00
CM-XXXX-7312	Bi-color 12V LED (add suffix 7312 to desired model number)	16.00
CM-XXXX-7412	Amber 12V LED (add suffix 7412 to desired model number)	16.00
CM-XXXX-7024	Red 24V LED (add suffix 7024 to desired model number)	16.00
CM-XXXX-7124	Green 24V LED (add suffix 7124 to desired model number)	16.00
CM-XXXX-7224	Red and Green 24V LED's (add suffix 7224 to desired model number)	32.00
CM-XXXX-7324	Bi-color 24V LED (add suffix 7324 to desired model number)	16.00
CM-XXXX-7424	Amber 24V LED (add suffix 7424 to desired model number)	16.00
CM-XXXX-DUR	Duranodic (US40) finish	14.00
CM-XXXX-PB	Polished Brass finish (US3)	34.00

CM-3000
Faceplate
(Shown with
optional LED)



CM-1000-DUR

HEAVY DUTY POWER TRANSFER CABLES

Model	Description	List Price
CM-PTS14	12" Length 1/4" Inside Diameter Cable, *US26, molded end caps	16.00
CM-PT14	18" Length, 1/4" Inside Diameter Cable, *US26, aluminum end caps	38.00
CM-PT38	18" Length, 3/8" Inside Diameter Cable, **US26, aluminum end caps	48.00
CM-PTSS-7	7" Length, 1/4" Inside Diameter, *Stainless Steel Cable and end caps	20.00
CM-PTSS-12	12" Length, 1/4" Inside Diameter, *Stainless Steel Cable and end caps	22.00
CM-PTSS-18	18" Length, 1/4" Inside Diameter, *Stainless Steel Cable and end caps	24.00
CM-PTSS38-7	7" Length, 3/8" Inside Diameter Cable, **US26, Stainless Steel Cable and end caps	24.00
CM-PTSS38-12	12" Length, 3/8" Inside Diameter Cable, **US26, Stainless Steel Cable and end caps	26.00
CM-PTSS38-18	18" Length, 3/8" Inside Diameter Cable, **US26, Stainless Steel Cable and end caps	28.00
CM-PT516M	Concealed Power Transfer Cable, 5/16" Inside Diameter, mortise mount	50.00

PTSS models are available in lengths up to 72". Contact factory for pricing and delivery

*** 1/4" ID. models for 4 conductor, 22 gauge or 2 conductor 18 gauge wire**

**** 3/8" ID. models for 16 conductor, 22 gauge or 8 conductor 18 gauge wire**

PRESSURE GAUGES

Model	Description	List Price
CM-PG1	0-7 lb. pressure gauge	60.00
CM-PG2	0-35 lb. pressure gauge	80.00
CM-PG3	10-50 lb. pressure gauge	128.00

Use PG-1 to measure swing door closing force, or switch activation force.

Use PG-2 to measure auto door opening force (swinging, sliding or overhead).

Use PG-3 to measure opening force as well as door sidelite breakout force.



CM-PT516M



CM-PTS14



CM-PT14

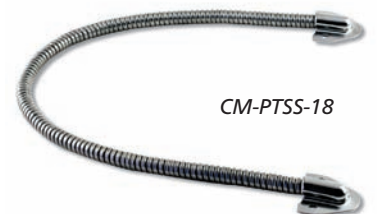

CM-PTSS-18



CM-PG

KEY PADS

An extensive line of keypads ranging from light duty mechanical models to vandal and weather proof piezo versions.

FEATURES

- Self-contained (one piece) or separate controller (two part) models
- Stand-alone, or wiegand outputs
- Surface or flush mount
- Narrow or single gang widths
- Illuminated or non-illuminated outputs



CM-120i



CM-500SK



CM-100SS



CM-120W



CM-480K



CM-100SN V2

LIGHT/MEDIUM DUTY MODELS

Model	Max. Users	Mounting	Outputs	Voltage	Outdoor Use	Illuminated	List Price
CM-120i	999	Flush	2 form C	12/24V AC/DC	NO	NO	124.00
CM-500SK	500	Surface	2 form C	12V AC/DC	YES	NO	182.00

These models are not designed for high usage or vandal-resistant applications.

While CM-120i and 500SK may be used outdoors, they are not recommended for applications where there is direct exposure to driving rain or snow.

VANDAL RESISTANT MODELS

Model	Max. Users	Mounting	Outputs	Voltage	Outdoor Use	Illuminated	List Price
CM-100SS	100	Surface	1 form C	12/24V AC/DC	YES	YES	440.00
CM-120W	999	Flush	2 form C	12/24V AC/DC	YES	YES	200.00
CM-480K	480	Surface	1 form C	12/24V AC/DC	YES	YES	440.00
CM-100SN V2	100	Surface	2 form C, 1 N/O	12/24V AC/DC	YES	YES	440.00
CM-100KPN V2	Additional keypad for CM-100SN				YES	YES	320.00

PIEZO models are fully sealed, and incorporate a patented one-piece design with no moving parts. Lifetime warranty on all piezo models.

FEATURES

- One-piece aluminum housing
- 200 user codes, 100 million combinations
- Visual & audible feedback during programming
- EEPROM memory
- Heavy-duty form C relay
- Easy to install and use

SPECIFICATIONS

- Temperature: -40°C to 125°C (-40°F to 257°F)
- Jamb width dimensions: 7 1/4" x 1 3/4" x 15/16" (184 mm x 45 mm x 24 mm)
- Single gang dimensions: 5 1/4" x 3 5/16" x 3/4" (133 mm x 85 mm x 19 mm)

LIFETIME WARRANTY

NO MOVING PARTS



CM-626

PIEZO - SELF CONTAINED (ONE PART)

Model	Max. Users	Mounting	Outputs	Voltage	Outdoor Use	Illuminated	List Price
CM-626S	200	Surface, Jamb	1 form C	12V AC, 12-24 VDC	YES	NO	500.00
CM-634	200	Surface, Single Gang	1 form C	12V AC, 12-24 VDC	YES	NO	500.00
CM-634i	200	Surface, Single Gang	1 form C	12V AC, 12-24 VDC	YES	YES	860.00



CM-634

PIEZO - WIEGAND OUTPUT

Model	Max. Users	Mounting	Outputs	Voltage	Outdoor Use	Illuminated	List Price
CM-626SW	Unlimited	Surface Jamb	26 bit wiegand	12-24 VDC	YES	NO	480.00
CM-6268W	Unlimited	Surface Jamb	8 bit wiegand	12-24 VDC	YES	NO	480.00
CM-634W	Unlimited	Surface, Single Gang	26 bit wiegand	12-24 VDC	YES	NO	480.00
CM-634iW	Unlimited	Surface, Single Gang	26 bit wiegand	12-24 VDC	YES	YES	680.00

NOTE: Other wiegand outputs available on request.



CM-634i
Illuminated

INDUSTRIAL DOOR AND GATE CONTROLS



Door and Gate Controls are designed for use in factories, warehouses, and other industrial applications. Models are UL/CSA listed, and most are NEMA rated for use in wet / outdoor environments. For activating overhead doors, storefront grilles and shutters.

Tamper Resistant Key/Gate Switches include a heavy duty faceplate, die cast aluminum enclosure with rubber gasket, 2 SPST momentary switches, (N/O) rated 3A @ 240V AC, and cylinder with 2 keys. UL listed, CSA certified. Anti-tamper feature: housing can only be opened with key. (KF and KX series).



CI-1KF



CI-1KFS



CI-1KX



CI-1KSMX



CI-GKS1

KEY/GATE SWITCHES

Model	Description	List Price
INTERIOR USE		
CI-1KF	Flush mount key switch, NEMA 1 and 2	120.00
CI-1KFS	As above, with heavy duty stop button, NEMA 1 and 2	144.00
EXTERIOR USE		
CI-1KX	Diecast aluminum key switch, painted gray enamel, NEMA 1, 2, 3R, 4, 6, 12, 13, and ICS	130.00
CI-1KXS	As above, with weatherized stop button NEMA 1, 2, 3R, 4, 6, 12, 13, and ICS	160.00
CI-1KSMX	Single gang enclosure, complete with spring loaded weather resistant cover	200.00
GATE SWITCHES		
CI-GKS1	Post mounted gate switch, SPDT, 3 AMPS @ 240V AC, die cast aluminum enclosure, black matte finish	82.00
CI-GKS2	As above, with 2 SPDT switches	92.00

INDUSTRIAL DOOR AND GATE CONTROLS

Mortise Cylinder Industrial Key Switch is designed to control grilles or gates where a high-security cylinder is required. Works with all 1" – 1 1/4" mortise and IC core cylinders, including Medeco, Best, Assa, Abloy, and Schlage. Includes double gang stainless steel faceplate, 2 x SPST N/O switches, red emergency STOP button, surface mount ABS box, rubber gasket, and tamper proof screws. Mortise cylinder not included. For Best style housings and IC cores, see P. 31.



MORTISE CYLINDER INDUSTRIAL KEY SWITCH

Model	Description	List Price
CI-3502	Industrial Key Switch	180.00



CI-3502

PUSH BUTTON CONTROL STATIONS

Model	Description	List Price
INTERIOR USE		
CI-PBU3	3 Button, Open / Close / Stop, NEMA 1, surface mount, 5 AMP @ 240V AC	34.00
CI-PBS3	3 Button, Open / Close / Stop, NEMA 1, 3 AMP @ 250V AC, stainless faceplate, flush or surface mount	74.00
EXTERIOR USE		
CI-3BX	3 Button, Open / Close / Stop, UL / CSA rated, 3 AMP @ 240V AC, NEMA 4	150.00
CI-3BXL	As above, with key lockout	210.00



CI-PBU3



CI-PBS3



CI-3BXL

CEILING PULL SWITCHES

Model	Description	List Price
CI-SCP1 (Replaces CI-CP1)	Diecast aluminum enclosure, supplied with 20' cord and pull handle, SPDT momentary, 3 AMP @ 240V AC. NEMA 1, 2, 3R, 4, 6, 12, 13, and ICS	110.00
CI-WPS1	Ceiling/wall pull switch with 360° rotating arm and pivoting cam. Ideal for activating industrial doors or use by lift truck operators, SPST momentary, 3 AMPS @ 240V AC, NEMA 4	160.00



CI-SCP1



CI-WPS1

TELEPHONE/ACCESS CONTROL SYSTEM



CV-TAC400 provides a full array of 'large system' features, combining telephone entry and card access at a remarkable 'small system' price. InVision TAC™ supports the addition of card readers, elevator controls, RF controls and other wiegand devices, allowing for a fully integrated building security system. CV-TAC400 has been designed for easy property management. The system can be ordered for local (hardwire) programming via USB connection, where there is on-site management. Or it can be supplied with a modem, making it ideal for multiple building, off-site system management.

CV-TAC400 provides the ability to add fully integrated card access performance, easily and affordably. Both the telephone entry and access control systems utilize a common configuration and reporting software platform. CV-TAC400 is offered with a choice of HID/AWID compatible card readers. Camden also has a wide selection of other wiegand readers, keypads, and RF controls that may be used with the system.

For use in apartment/office buildings, condominiums, rec/sports centers, and other applications where a combination of security and communications are required for controlling resident and visitor traffic.



CV-TAC 400

TELEPHONE ENTRY FEATURES

- Built-in electronic display, with 8 line tenant listing
- 500 name directory
- Full audit capability for all entrances and other secured areas
- Master/slave configuration; up to 3 slave panels for visitor parking, garages, etc.
- Robust keypad with dedicated scroll and call buttons
- 15 digit dialing
- Supports after-hour auto attendant
- Local (via USB) or remote (via telephone modem) programming
- Supports PIN code access for emergency and other services
- Built-in proximity reader (optional)
- Wiegand output (for integration with other access control systems)
- Heavy-duty stainless steel faceplate
- Flush mount enclosure, with optional vandal/rain hood.
- Optional stainless steel surface enclosure with rain hood
- Optional heater kit

ACCESS CONTROL FEATURES

- HID/AWID format card reader built into front face of lobby panel, and up to 3 slave panels
- Up to 12 CV-TAC4WC Wiegand controllers, for adding card readers or other Wiegand devices (one device per controller)
- Up to 3,000 user codes
- 20 time zones, 8 access levels, and holiday schedules
- 4000 audit transactions
- RS485 polling
- Supervised inputs throughout the system
- Elevator control, up to 48 floors, 4 cabs per system

TELEPHONE/ACCESS CONTROL SYSTEM

ENTRY PANELS AND ENCLOSURES

Model	Description	List Price
CV-TAC400B	Master directory, 8 line electronic display, with USB/485 interface for local programming/monitoring. Transformer, software included.	2120.00
CV-TAC400M	Master directory, 8 line electronic display, with modem for off-site programming/monitoring. Transformer, software included.	2222.00
CV-TAC400S	Slave directory, 8 line electronic display with transformer.	1860.00
CV-TAC4FB	Flush mount 'Rough-In' box	94.00
CV-TAC4SB	Surface mount enclosure, stainless steel	260.00
CV-TAC4FH	Vandal/rain resistant hood for flush or surface mount box, stainless steel	200.00



CV-TAC4FB
Flush Mount
'Rough-in' Box



CV-TAC4SB
Surface Mount
Enclosure



CV-TAC4FH
Vandal / Rain Hood
(Use with flush or
surface mount enclosure)



CV-TAC4WC
Wiegand Controller



CV-7400
Card Reader



CV-5395
Card Reader



CV-CSH
Cards



CV-KTH
Fobs

PANEL ACCESSORIES

Model	Description	List Price
CV-TAC4USB	RS485/USB computer interface module (supplied with CV-TAC400B) required for CV-TAC400M local programming	227.00
CV-TAC4H	Heater kit, includes transformer, for outdoor use -22F to +122F (-30C to +50C)	200.00
CV-TAC4P	Handset, for privacy or noisy lobby environments	160.00

PANEL MOUNT CARD READERS

Model	Description	List Price
CV-TAC4PRA	HID/AWID format prox reader, mounted in TAC400 Panel	220.00

ELEVATOR CONTROL

Model	Description	List Price
CV-TAC4EL	Elevator controller (one required per 16 floors, per cab)	1600.00

NOTE: (1) CV-TAC4WC required for each elevator cab.

ACCESS CONTROL DEVICES, READERS AND CARDS

Model	Description	List Price
CV-TAC4WC	Wiegand controller for adding up to 12 remote prox readers, RF, or keypads. Up to 4 additional wiegand controllers can be designated for elevator cab control	340.00
CV-7400	HID/AWID format prox reader, mullion style, up to 4"-5" read range	170.00
CV-7820	AWID format prox reader, single gang, up to 6"-8" range	280.00
CV-CSA	AWID prox cards, clam shell style (100 per box)	3.80 EA.
CV-KTA	AWID prox key tag (25 per tube)	7.20 EA.
CV-5395	HID Thinline II low profile single gang reader, up to 4"-5" read range	420.00
CV-CSH	HID ProxCARD II, clam shell style (100 per box)	5.00 EA.
CV-KTH	HID ProxKey tag (10 per tube)	9.80 EA.

NOTE: All prox cards and fobs are sold in multiples of 10 pcs. except CV-KTA (25 pcs.)

For additional prox readers and wiegand keypads, see page 42. TAC400 may be used with all devices that provide a 26 bit wiegand output.

TELEPHONE/ACCESS CONTROL SYSTEM

GUARD/CONCIERGE PHONE SYSTEM

This auto-dialer is designed for staffed locations, where an attendant will greet visitors, call the resident's suite for authorization, then allow/deny access accordingly. Up to 1000 suite capacity. Kit includes keypad and privacy handset/cradle. There is no directory provided with this system.

GUARD/CONCIERGE PHONE SYSTEM

Model	Description	List Price
CV-TAC400G	Auto dialer for guard (concierge) station, with software, keypad and handset	1820.00

For additional auto-dial and no phone bill solutions, contact the factory.



CV-TAC400G

TELEPHONE ENTRY / ACCESS CONTROL INTERFACE

CV-800 Serial to Wiegand Converters, provide a flexible and efficient way to integrate a telephone entry system with an access control system, CV-800 works with virtually all card access systems, and select models of Viscount, SES, and Sentex phone entry systems.

Building security is greatly enhanced as CV-800 allows the access control system to manage/control the building entrance – not the telephone entry system. In addition, CV-800 provides the building owner and manager with a complete audit trail of all persons entering the building, as well as a record of residents granting visitors access via the telephone entry system. CV-800 also monitors the postal lock switch.

TELEPHONE ENTRY / ACCESS CONTROL INTERFACE

Model	Description	List Price
CV-800EP	For use with Viscount Enterphone 2000™ (requires firmware 2.4 or greater)	620.00
CV-800VE	For use with Viscount Electra™	620.00
CV-800SES	For use with SES TEC & CAT Series™	620.00
CV-800SEN	For use with Sentex Infinity Series™	620.00



CV-800EP

SINGLE DOOR PROXIMITY CARD READERS

CV-600 MPROX is Camden's newest stand-alone proximity reader system. Designed for use in industrial and commercial applications. MPROX provides excellent security and functionality, and is easy to program and install.

MPROX consists of two parts: a vandal and weather resistant mullion-mount proximity reader, and a small programmer/controller, which is installed on the secure side inside the facility. An additional reader can be added for in-out control of a single door or for ease of programming. The system has a capacity of 999 users. Cards/fobs can be individually or batch enrolled/deleted. All programming is done through the controller and reader – there is no need for computers or software to enroll or delete cardholders.

FEATURES

- Up to 999 users
- Jamb-mount proximity reader
- Vandal and water resistant reader (IP 67)
- Reader and controller may be up to 200 ft (70 metres) apart
- Operates with prox cards or fobs
- Request-To-Exit input (N/O)
- Bi-color LED and sounder
- Door open time: 1 - 180 seconds, or latching
- Programming password (optional use)
- Form C (N/O + N/C) relay, 5 amps
- 12/24V AC/DC operation
- Presence Input (parking, mantrap applications)



CV-600R



CV-7400



CV-500PPK V2



CV-500AR



CV-500PC/PT

Model	Description	List Price
CV-600	MPROX controller with CV-600R mullion prox reader, 1" - 2" read range	340.00
CV-600R	Reader only for CV-600	150.00
CV-CSH	Prox card for CV-600 (100 per box)	5.00 EA.
CV-KTH	Prox key fob for CV-600 (10 per tube)	9.80 EA.
CV-601	MPROX controller with CV-7400 mullion prox reader, 4" - 5" read range	360.00
CV-7400	Reader only for CV-601	170.00
CV-CSA	Prox card for CV-601 (100 per box)	3.80 EA.
CV-KTA	Prox key fob for CV-601 (25 per packet)	7.20 EA.

Note: All cards and fobs are sold in multiples of 10, except CV-KTA (25).

CV-500PPK V2 is a stand-alone, single door proximity reader with up to 500 users – cards, fobs or keypad activation. Cards may be individually or block enrolled. Easy installation and usage – software or hand-held programmers are not required. Optional stainless steel prox reader is ideal for vandal-prone areas.

Model	Max. Users	Mounting	Outputs	Voltage	Outdoor Use	Vandal Resistant	Illuminated	List Price
CV-500PPK V2	500	Surface, Single Gang	1 form C	12V AC/DC	YES	NO	NO	370.00
CV-500AR	Auxiliary stainless steel reader for use with CV-500PPK				YES	YES	NO	420.00

PROXIMITY CARDS FOR CV-500PPK

Model	Description	List Price
CV-500PC	Proximity Card for CV-500PPK (100 per box)	3.60 EA.
CV-500PT	Proximity plastic fob for CV-500PPK (20 per box)	7.00 EA.

INVISION 32 ACCESS CONTROL

On-line distributed processing access control system for up to 64 doors. Kits include 2 door controller, software, 2 proximity readers (choice of formats and read range), power supply, and plug-in transformer (16V-40VA). Expandable to 128 doors with optional software module.

Model	Description	List Price
KITS		
CV-32	Control panel with software, power supply, and plug-in transformer	1140.00
CV-32H1	Control panel with software, power supply, plug-in transformer, 2 HID format mullion readers	1400.00
CV-32H2	Control panel with software, power supply, plug-in transformer, 2 HID format single gang readers	1600.00
CV-32A1	Control panel with software, power supply, plug-in transformer, 2 AWID compatible mullion readers	1360.00
CV-32A2	Control panel with software, power supply, plug-in transformer, 2 AWID compatible single gang readers	1540.00
OPTIONS		
CV-128	Expands system to 128 reader capacity	1000.00
CV-LNM	LAN interface module (TCP/IP)	480.00
CV-CCM	RS232 to RS485 converter. Enables computer to be hardwired up to 4000 ft from controller.	360.00
CV-RS485	CV-RS485 USB to RS485 converter. Enables computer to be hardwired up to 4000 ft from controller.	400.00
CV-SU	Firmware upgrade to 3.5	100.00
CV-RMOD	Exit reader module	140.00
CV-ELCON	Elevator controller with one 8-floor relay board	1600.00
CV-EL8	8 floor elevator module with wall-mount metal enclosure	680.00
CV-EL16	16 floor elevator module with wall-mount metal enclosure	1280.00



CV-32 A1

HARDWARE

- Flash firmware technology for easy upgrades
- Supports 2 card readers – card reader/keypad combo per panel
- R-MOD enables in/out control of one door on each reader port
- Stores up to 3,000 transactions off-line
- Supports fully supervised communication via RS-232, RS-485 and TCP/IP
- 8 fully supervised programmable inputs (4 state monitoring alarms)
- 8 programmable outputs
- Reads 5 card formats per panel
- TCP/IP network ready (CV-LNM required)
- 12V DC @ 2A power supply (included)
- Battery back-up on system memory
- HVAC and Lighting Control
- Elevator control 8 to 32 floors (optional hardware required)

SOFTWARE

- Up to 64 reader capacity, expandable to 128
- 5000 cardholders per panel (upgradeable to 8000)
- 40 holiday schedules
- Auto card expiry by date up to five years in advance
- Multiple credentials per user
- Global and timed anti-passback
- Time and attendance reports
- Multiple language – English, French, Spanish and Chinese
- Unlimited global link commands
- Customized formats for exporting reports
- Advanced client-server design with up to 10 simultaneous full function clients over LAN/WAN
- Multiple-site management
- Multi-swipe functionality (2, 3, and 4 swipes)
- Visitor management
- Photo badging (optional)
- Card import (from other systems - optional)

INVISION 32 ACCESS CONTROL

Model	Description	List Price
HID READERS		
CV-5395	HID Thinline II low profile single gang reader, 4"-5" read range	420.00
CV-5455	HID ProxPro II, single gang reader, 6"-9" read range	420.00
CV-5375	HID MaxiProx reader, 16"-29" read range	1100.00
CV-653PR	HID Vandal proof prox reader	620.00
CV-5355KP	HID ProxPro with keypad	720.00
HID CARDS*		
CV-CSH	HID Proxcard II, clam shell style (100 per box)	5.00 EA.
CV-KTH	HID Proxkey, key tag (10 per tube)	9.80 EA.
AWID READERS		
CV-7500	AWID compatible prox reader, mullion style, 4"-5" read range	170.00
CV-7500P	Single gang adapter plate	36.00
AWID CARDS		
CV-CSA	AWID prox card, clam shell style (100 per box)	3.80 EA.
CV-KTA	AWID prox key tag (25 per packet)	7.20 EA.
HID/AWID READER		
CV-7400	HID/AWID format prox reader, mullion style, up to 4"-5" read range	170.00

Cards and fobs are sold in multiples of 10, except CV-KTA (25).
 *A full range of HID and AWID compatible prox readers and cards are available.
 Contact factory for details.



CV-634PR models integrate with most access control systems, and incorporate HID prox readers with our patented piezo keypad technology. They read all standard HID card formats.

- Voltage: 5-12VDC
- Current Draw: 150ma
- Reader Output: HID Wiegand
- Keypad Output: 8 bit or 26 bit Wiegand
- Temperature: -20°C to 75°C (-4°F to 158°F)
- Dimensions: 4 3/4" x 3 1/2" x 3/4" (120mm x 90mm x 20mm)



PIEZO KEYPADS / HID PROX READERS							
Model	Max. Users	Mounting	Outputs	Voltage	Outdoor Use	Illuminated	List Price
CV-634PR	Unlimited	Surface, Single Gang	Wiegand/26 bit keypad	5-12 V DC	YES	NO	820.00
CV-6348PR	Unlimited	Surface, Single Gang	Wiegand/8 bit keypad	5-12 V DC	YES	NO	820.00

PIEZO KEYPADS - WIEGAND OUTPUT							
Model	Max. Users	Mounting	Outputs	Voltage	Outdoor Use	Illuminated	List Price
CM-626SW	Unlimited	Surface Jamb	26 bit wiegand	12-24 VDC	YES	NO	480.00
CM-6268W	Unlimited	Surface Jamb	8 bit wiegand	12-24 VDC	YES	NO	480.00
CM-634W	Unlimited	Surface, Single Gang	26 bit wiegand	12-24 VDC	YES	NO	480.00
CM-634iW	Unlimited	Surface, Single Gang	26 bit wiegand	12-24 VDC	YES	YES	680.00



COVERT FACIAL IDENTIFICATION CAMERAS



NEXIT WATCH™ COVERT DOOR FRAME, HIGH RESOLUTION COLOR CAMERAS

Exit Watch is installed on the frame of the exit door, which is the ideal location to capture clear and close-up video images. To all appearances, the unit is a typical height strip you would see anywhere. Exit Watch provides positive facial identification - perfect for use in banks, restaurants, filling stations and other retail applications.

The high quality optical lens and ultra-small high resolution CCD camera makes Exit Watch one of the most advanced units available. The heavy duty, dark brown or silver steel case and back-screened multi-color faceplate are designed to keep the unit looking new by protecting it in high traffic areas.

The adjustable/lockable swivel bracket mounts directly to the door frame, enabling Exit Watch to be precisely adjusted for single or double door applications. Exit Watch provides clear and distinct images to law enforcement agencies for identification needs.

The compact EX-7 (6.5" long) can be mounted on either the door frame or over the door (horizontally). Exit Watch kit includes mounting hardware and 12 VDC regulated plug-in power transformer.

COVERT DOOR FRAME CAMERAS

Model	Description	List Price
CV-EX36	Color 525 TVL, 3.7mm lens, min. illum. 1 Lux @ f:2.0, dark brown case	700.00
CV-EX36S	Color 525 TVL, 3.7mm lens, min. illum. 1 Lux @ f:2.0, with silver (aluminum) finish	700.00
CV-EX7	Mini Cam, Color 525 TVL, 3.7mm lens, min. illum. 1 Lux @ f:2.0, dark brown case	700.00
CV-EX7S	Mini Cam, Color 525 TVL, 3.7mm lens, min. illum. 1 Lux @ f:2.0, with silver (aluminum) finish	700.00

Now available in choice of dark brown or silver finish



CV-EX7



CV-EX36

Installed in minutes, Exit Watch provides high resolution images required for identification purposes.



Lockable swivel bracket allows for single or double door use.

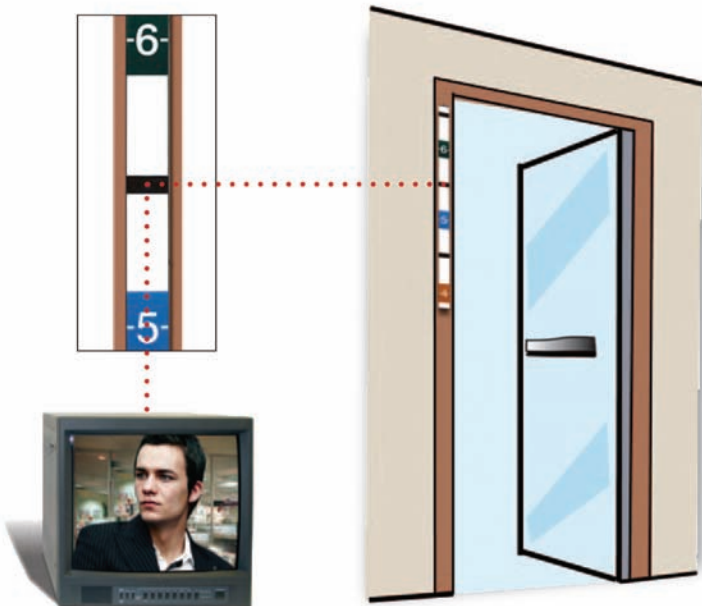

PRODUCT INDEX

Model/Series	Description	Page Location	Model/Series	Description	Page Location
EXPRESS INDUSTRIAL			CM-250 series	Jamb push buttons	17
CI-1K series	Key switches	35	CM-280 series	Single gang push buttons	17
CI-3BX series	Push button controls	36	CM-300/310 series	Illuminated push buttons	11
CI-3502	Industrial key switch	36	CM-324	Hands-free switches	19
CI-SCP1	Ceiling pull switch	36	CM-400/410/420 series	Mushroom push buttons	14
CI-GK series	Gate switches	35	CM-419	Request-to-exit sensors	20
CI-PB series	Push button controls	36	CM-440	S/S dress plate	25
CI-WPSI	Wall pull switch	36	CM-480K	Keypad	33
EXPRESS			CM-480C	RF controller	23
CM-23	Jamb box	25	CM-500SK	Keypad	33
CM-25 series	Jamb push switches	21	CM-520 series	Mushroom push buttons	14
CM-30/30EE series	Illuminated push buttons	11	CM-626 series	Piezo keypads	34
CM-31	s/s sleeve for single gang box	25	CM-634 series	Piezo keypads	34
CM-34AL/D	Single gang mounting boxes	27	CM-660	S/S dress plate	25
CM-34BL	Single gang mounting box	25	CM-700 series	Emergency pull stations	20
CM-35 series	Single gang push switches	21	CM-700GL	Glass break rods	20
CM-40 series	4 1/2" round push switches	21	CM-720 series	Emergency pull stations	20
CM-41 series	4 1/2" round/square push switches	21	CM-810/820/830/840/850	Remote release switches	19
CM-42 series	Switch mounting posts	26	CM-1000 series	Surface mount key switches	29
CM-43CBL	Double gang mounting box	25	CM-1100 series	Flush mount key switches	29
CM-44	Offset jamb mounting box	25	CM-1200 series	Flush mount key switches	30
CM-45 series	4 1/2" square push switches	21	CM-2000 series	Jamb key switches	29
CM-46 series	4 1/2" square push switches	21	CM-2200 series	Jamb key switches	30
CM-47	Round Surface mount box	25	CM-2510 series	Combo key/push switch	21
CM-48	Surface mount kit	25	CM-2520	Vestibule switch	21
CM-48 series	Switch mounting posts	26	CM-3000/3100 series	Illuminated push buttons	12
CM-49	Round surface/flush mount kit	26	CM-3200 series	Double gang key switches	30
CM-59S	Stainless steel escutcheon	25	CM-3500 series	Double gang key switches	30
CM-53	Double gang mounting box	25	CM-4000/4100 series	Mushroom push buttons	13
CM-60 series	6" round push switches	21	CM-5000 series	Mushroom palm buttons	13
CM-63CBL	Double gang mounting box	25	CM-6000 series	Locking palm buttons	13
CM-64	Offset jamb mounting box	25	CM-7000/7100 series	Push buttons	14
CM-66	s/s flush mount box	25	CM-8000/8100 series	Push buttons	14
CM-67	s/s surface mount box	25	CM-9000/9100 series	Vandal resistant push buttons	15
CM-68	Surface mount kit	25	CM-9200-9300 series	Piezo push buttons	15
CM-69S	Round surface mount box	25	CM-9600 series	Piezo push buttons	16
CM-79	Round surface/flush mounting kit	26	CM-9700 series	Piezo push buttons	16
CM-89S	s/s Escutcheon	25	CM-PG series	Pressure gauges	32
CM-100SN	Keypad	33	CM-PT series	Power transfer cables	32
CM-100SS	Keypad	33	CM-RFL	RF switch packages	24
CM-120 series	Keypads	33	CM-RX series	RF receivers	23
CM-130	Rotary switch	22	CM-TX series	RF transmitters	23
CM-150 series	Push buttons w/enclosure	17	INVISION		
CM-160 series	Auto door key switches	22	CV-32 series	Card access system	41
CM-170 series	Auto door key switches	22	CV-500AR	Prox reader	40
CM-180 series	Auto door key switches	22	CV-500PPK	Prox reader	40
CM-190 series	Toggle switches	22	CV-600/601	Single door proximity	40
CM-200 series	Horizontal switches	17	CV-634PR	Piezo keypad/prox	42

PRODUCT INDEX

Model/Series	Description	Page Location	Model/Series	Description	Page Location
CV-653PR	Prox reader	42	CX-EL1400	Electric strikes	3
CV-800	Phone/access system interface	39	CX-EL2000	Electric strikes	3
CV-7400	Prox reader	42	CX-EL2200	Electric strikes	3
CV-7500	Prox reader	42	CX-EL3000	Electric strikes	4
CV-EX7	Exit watch mini camera	43	CX-EL4000	Electric strikes	4
CV-EX36	Exit watch door frame camera	43	CX-EL8000	Cabinet Locks	4
CV-TAC400	Telephone entry system	37	CX-EMF2	Multi-function relay	9
EXACT			CX-EU2000	Electric strikes	3
CX-12	Switching network	8	CX-PC6	Lock-out relay	8
CX-22	Bi-directional sequencer	9	CX-PS series	Power supplies	10
CX-90 series	Mag locks	5	CX-SAI	Switching network	8
CX-91 series	Mag locks	5	CX-TRN series	Transformers	10
CX-92 series	Mag locks	5	CX-TRP series	Transformers	10
CX-93 series	Gate lock	5	CX-TRX series	Transformers	10
CX-94 series	Shear lock	5	CX-WC series	Restroom control kit	9
CX-247 series	7 day timers	7	PARTS & ACCESSORIES		
CX-1000/74	Time delay	7	Electric strikes, faceplates		4
CX-1000/75	Time delay	7	Key switch parts		31
CX-1000/77	Time delay	7	LED's/replacement bulbs		18
CX-1000/78	Time delay	7	Mag lock accessories		6
CX-1085	Pneumatic Timers	8	Push button parts		18
CX-5024	Rectifier	10	Tamper proof screws		18
CX-ED1000	Electric strikes	3			

TERMS AND CONDITIONS

Prices: All prices are in U.S. dollars, and are subject to change without notice.

Freight: All goods are shipped F.O.B. Camden warehouses. Deliveries are made via FedEx / UPS ground service, unless otherwise specified by customer. Customer must make any claims for damage in transit or missing boxes directly with the transport company. Claims for packing and/or ordering errors should be made directly to Camden within ten days of receipt of merchandise.

Minimum Order: The minimum order is \$100.00 net. Orders under \$100.00 net are subject to a \$25.00 handling fee.

Payment Terms: Net 30 days.

Return Policy: Returns will not be accepted unless accompanied by a Return Goods Authorization (RGA) number. Contact factory for details.

Warranty: All Camden product carry a 3 year warranty. Electric strikes offer a 5 year warranty. Piezo electric switches and magnetic locks carry a free lifetime warranty. This warranty applies to products that have failed in the course of normal use, and not the result of improper installation or vandalism. Upon inspection, Camden will repair / replace returned goods, or issue credit. Returns must be shipped freight prepaid, and will be returned freight prepaid. Please note any shipment sent to Camden freight collect, will be refused. All returns must be accompanied by a returned goods authorization (RGA). Contact Camden for details.

Effective: February 1, 2011